

ETSI/TC GSM
Released by : ETSI/PT 12
Release date: January 1990

RELEASE NOTE

Recommendation GSM 03.40

Technical Realization of Short Message
Service - Point to Point

- previous released version : 3.1.1
- new released version : 3.4.0

1. Reason for changes

Changes agreed at GSM 24, GSM 25 and at GSM 25 bis are included.

2. Details of changes

CR	Title	Sections modified	Ref GSM Doc
GSM 24			
CR 03.40-10	Use of Suppl. Services for the Short Message Serv.	3, Anx	319/89
(Resulting in version 3.2.0)			
GSM 25			
CR 03.40-11	Origin. Address for MO-SM	9.2	390/89
CR 03.40-13	Parameter Diagram	Anx	392/89
(Resulting in version 3.3.0)			
GSM 25bis			
CR 03.40-12 r1	Single MSISDN in Alert-SC	3,9,anx	32/89
(Resulting in version 3.4.0)			

ETSI/GSM

Released by: ETSI PT12
Release date: January 1990

Recommendation : GSM 03.40

Title: TECHNICAL REALIZATION OF THE SHORT MESSAGE SERVICE
- POINT-TO-POINT

List of contents:

0. Scope
1. Introduction
2. Definitions and abbreviations
3. Services and service elements
4. Network Architecture
5. Service Centre and PLMN interconnection
6. Service Centre functionality
7. MS functionality
8. MSC functionality
9. Protocols and protocol structure
10. Procedures within the point-to-point services

Annex 1: A protocol stack for interconnecting SCs and MSCs
Annex 2: Default alphabet, and coding scheme
Annex 3: Short message information flow

Original language: English

Number of pages: 100

THIS PAGE DOES NOT CONTAIN ANY TEXT

TABLE OF CONTENTS

0.	Scope	7
1.	Introduction	7
2.	Definitions and abbreviations	8
	2.1. Key definitions	8
	2.2. Abbreviations	9
3.	Services and service elements	10
	3.1. Basic services	10
	3.2. Short Message Service elements	12
	3.2.1. Validity-period	12
	3.2.2. Service-Centre-Time-Stamp	12
	3.2.3. Protocol-Identifier	12
	3.2.4. More-Messages-to-Send	12
	3.2.5. Priority	13
	3.2.6. Message-Waiting	13
	3.2.7. Alert-SC	14
	3.2.8. Options concerning MWF and MWD	15
	3.3. Unsuccessful short message TPDU transfer SC -> MS	15
	3.4. Unsuccessful short message TPDU transfer MS -> SC	17
	3.5. Use of Supplementary Services in combination with the Short Message Service	17
4.	Network architecture	18
	4.1. Basic network structure	18
	4.2. Transfer on link 3	19
5.	Service Centre and PLMN interconnection	19
	5.1. Service Centre connection	19
	5.2. Routing requirements	20
	5.2.1. Mobile terminated short message	20
	5.2.2. Mobile originated short message	20

TABLE OF CONTENTS (cont'd)

6.	Service Centre functionality	20
6.1.	Service Centre capabilities	20
6.2.	SC functional requirements	21
7.	MS functionality	21
7.1.	MS capabilities	21
7.2.	MS configuration	21
8.	MSC functionality	22
8.1.	MSC functionality related to SM MT	22
8.1.1.	Functionality of the SMS-GMSC	22
8.1.2.	Functionality of the MSC	23
8.2.	MSC functionality related to SM MO	24
8.2.1.	Functionality of the MSC	24
8.2.2.	Functionality of the SMS-IW MSC	25
8.3.	SMS-IW MSC functionality related to alerting	25
9.	Protocols and protocol interworking	26
9.1.	Protocol element features	26
9.1.1.	Octet and bit transmission order	26
9.1.2.	Numeric representation	26
9.1.2.1.	Integer representation	26
9.1.2.2.	Octet representation	28
9.1.2.3.	Semi-octet representation	28
9.1.2.4.	Address fields	28
9.2.	Service provided by the SM-TL	30
9.2.1.	General	30
9.2.2.	Service definition	31
9.2.3.	Definition of primitives	32
9.2.3.1.	TS-Deliver	32
9.2.3.2.	TS-Report	33
9.2.3.3.	TS-Submit	34

TABLE OF CONTENTS (cont'd)

9.2.4.	Definition of parameters	34
9.2.4.1.	TS-Short-Message-Identifier	34
9.2.4.2.	TS-Destination-Address	35
9.2.4.3.	TS-Originating-Address	35
9.2.4.4.	TS-Service-Centre-Address	35
9.2.4.5.	TS-Protocol-Identifier	35
9.2.4.6.	TS-Data-Coding-Scheme	35
9.2.4.7.	TS-Service-Centre-Time-Stamp	35
9.2.4.8.	TS-Message-Waiting-Set	35
9.2.4.9.	TS-Priority	35
9.2.4.10.	TS-Status-of-Report	36
9.2.4.11.	TS-More-Messages-to-Send	36
9.2.4.12.	TS-Validity-Period	36
9.2.4.13.	TS-Short-Message-Information	36
9.2.5.	PDU Type repertoire at SM-TL	36
9.2.5.1.	SMS-DELIVER type	37
9.2.5.2.	SMS-SUBMIT type	39
9.2.6.	Definition of the TPDU parameters	40
9.2.6.1.	TP-Message-Type-Indicator (TP-MTI)	40
9.2.6.2.	TP-More-Messages-to-Send (TP-MMS)	41
9.2.6.3.	TP-Validity-Period-Format (TP-VPF)	41
9.2.6.4.	TP-Message-Reference (TP-MR)	41
9.2.6.5.	TP-Originating-Address (TP-OA)	41
9.2.6.6.	TP-Destination-Address (TP-DA)	41
9.2.6.7.	TP-Protocol-Identifier (TP-PID)	41
9.2.6.8.	TP-Data-Coding-Scheme (TP-DCS)	43
9.2.6.9.	TP-Service-Centre-Time-Stamp (TP-SCTS)	43
9.2.6.10.	TP-Validity-Period (TP-VP)	43
9.2.6.11.	TP-User-Data-Length (TP-UDL)	44
9.3.	Service provided by the SM-RL	44
9.3.1.	General	44
9.3.2.	Service definition	44
9.3.3.	Definition of the primitives	48
9.3.3.1.	RS-MT-Data	48
9.3.3.2.	RS-MO-Data	48
9.3.3.3.	RS-Report	49
9.3.3.4.	RS-Error	49
9.3.3.5.	RS-Alert	50
9.3.4.	Definition of parameters	50
9.3.4.1.	RS-Short-Message-Identifier	50
9.3.4.2.	RS-Destination-Address	50
9.3.4.3.	RS-Originating-Address	50
9.3.4.4.	RS-Priority	50
9.3.4.5.	RS-Cause	50

TABLE OF CONTENTS (cont'd)

9.3.4.6.	RS-Alerting-MS	51
9.3.4.7.	RS-Messages-Waiting-Set	51
9.3.4.8.	RS-User-Data	51
9.3.5.	Protocol Element repertoire at SM-RL	51
9.3.5.1.	RP-MO-DATA	51
9.3.5.2.	RP-MT-DATA	52
9.3.5.3.	RP-ACK	52
9.3.5.4.	RP-ERROR	52
9.3.5.5.	RP-ALERT-SC	53
10.	Fundamental procedures within the point-to-point SMS	53
10.1.	Short message mobile terminated	54
10.2.	Short message mobile originated	65
10.3.	Alert transfer	73
Annex 1:	A protocol stack for interconnecting SCs and MSCs	74
1.	The transport service	74
2.	The session layer protocol	75
3.	The presentation layer	76
4.	Service elements on the application layer	76
5.	SMRSE definition	76
6.	Detailed specification of the SMRSE services	77
7.	Application rules for avoiding collision	90
8.	Timing terminology	91
Annex 2:	Default alphabet and coding scheme	94
Annex 3:	Short message information flow	96

0. SCOPE

This recommendation describes the point-to-point Short Message Service (SMS) of the GSM PLMN system. It defines:

- the services and service elements,
- the network architecture,
- the Service Centre functionality,
- the MSC functionality (with regard to the SMS),
- the routing requirements,
- the protocols and protocol layering,

for the Teleservices 21 and 22, as specified in the Rec. GSM 02.03.

The use of radio resources for the transfer of short messages between the MS and the MSC is described in Rec. GSM 04.11 'Point-to-Point Short Message Service Support on Mobile Radio Interface', and is dealt with in that recommendation.

The network aspects of Short Message Service provision are outside the scope of this recommendation (i.e. the provision of network connectivity between the PLMN subsystems). The required and assumed network service offered to the higher layers is defined in this recommendation.

The Cell Broadcast Short Message Service (Teleservice 23) is a separate service, and is described in Rec. GSM 03.41 'Technical Realization of the Short Message Service - Cell Broadcast'.

1. INTRODUCTION

The Point-to-Point Short Message Service (SMS) provides a means of sending messages of limited size to and from GSM mobiles. The provision of SMS makes use of a Service Centre, which acts as a store and forward centre for short messages. Thus a GSM PLMN needs to support the transfer of short messages between Service Centres and mobiles.

Two different point-to-point services have been defined: mobile originated and mobile terminated. Mobile originated messages will be transported from an MS to a Service Centre. These may be destined for other mobile users, or for subscribers on a fixed network. Mobile terminated messages will be transported from a Service Centre to an MS. These may be input to the Service Centre by other mobile users (via a mobile originated short message) or by a variety of other sources, e.g. speech, telex, or facsimile.

2. DEFINITIONS AND ABBREVIATIONS

2.1 Key definitions

Active MS: A switched-on mobile station with a SIM module attached.

Alert-SC: Service element provided by a GSM PLMN to inform an SC which has previously initiated unsuccessful short message delivery attempt(s) to a specific MS, that the MS is now recognized by the PLMN to have recovered operation.

Gateway MSC for Short Message Service (SMS-GMSC): An MSC capable of receiving a short message from an SC, interrogating an HLR for routing information and SMS info, and delivering the short message to the VMSC of the recipient MS.

Interworking MSC for Short Message Service (SMS-IWMSC): An MSC capable of receiving a short message from within the PLMN and submitting it to the recipient SC.

Messages-Waiting (MW): Service element that makes a PLMN store information (Messages-Waiting-Indication), listing those SCs that have made unsuccessful short message delivery attempts to MSs in that PLMN.

Messages-Waiting-Indication (MWI): Data to be stored in the HLR and VLR with which an MS is associated, indicating that there is one or more messages waiting in a set of SCs to be delivered to the MS (due to unsuccessful delivery attempt(s)).

Messages-Waiting-Data (MWD): The part of the MWI to be stored in the HLR. MWD consists of an address list of the SCs which have messages waiting to be delivered to the MS.

Messages-Waiting-Flag (MWF): The part of the MWI to be stored in the VLR. MWF is a boolean parameter indicating if the address list of MWD is empty (no SC has any messages waiting to be delivered to the MS) or not.

More-Messages-to-Send (MMS): Information element offering an MS receiving a short message from an SC the information whether there are still more messages waiting to be sent from that SC to the MS.

Priority: Service element enabling the SC or SME to request a short message delivery attempt to an MS irrespective of whether or not the MS has been identified as temporarily absent.

Protocol-Identifier: Information element by which the originator of a short message (either an SC or an MS) may refer to a higher layer protocol.

Report: Response from either the network or the recipient upon a short message being sent from either an SC or an MS. A report may be a delivery report, which confirms the delivery of the short message to the recipient, or it may be a failure report, which informs the originator that the short message was never delivered and the reason why.

When issued by the Service Centre, the delivery report confirms the reception of the Short Message by the SC, and not the delivery of the Short Message to the SME.

When issued by the Mobile Station, the delivery report confirms the reception of the Short Message by the Mobile Station, and not the delivery of the Short Message to the user.

Service Centre (SC): Function responsible for the relaying and store-and-forwarding of a short message between an SME and an MS. The SC is not a part of the GSM PLMN.

Short Message: Information that may be conveyed by means of the Short Message Service described in this recommendation.

Short Message Entity (SME): An entity which may send or receive Short Messages. The SME may be located in a fixed network, an MS, or an SC.

SMS-DELIVER: Short message transfer protocol data unit containing user data (the short message), being sent from an SC to an MS.

SMS-SUBMIT: Short message transfer protocol data unit containing user data (the short message), being sent from an MS to an SC.

Service-Centre-Time-Stamp (SCTS): Information element offering the recipient of a short message the information of when the message arrived at the SM-TL entity of the SC. The time of arrival comprises the year, month, day, hour, minute, second and time zone.

Validity-Period (VP): Information element offering the originator MS to indicate the time period during which the originator considers the short message to be valid.

2.2. Abbreviations

CUG : Closed User Group

MS: Mobile Station

MSISdn: ISDN number of the mobile subscriber

MT0 : Mobile Terminal with support of no terminal interfaces

ISDN: Integrated Services Digital Network

PLMN: Public Land Mobile Network

PSPDN : Packet Switched Public Data Network

ROSE: Remote Operations Service Element

ACSE: Association Control Service Element

SM MT : Short Message Mobile Terminated Point-to-Point

SM MO : Short Message Mobile Originated Point-to-Point

SM-AL : Short Message Application Layer

SM-TL : Short Message Transfer Layer

SM-RL : Short Message Relay Layer

SM-LL : Short Message Lower Layers

SM-TP : Short Message Transfer Layer Protocol
SM-RP : Short Message Relay Layer Protocol

SM-TS : Short Message Transfer Service
SM-RS : Short Message Relay Service

SMS : Short Message Service

TPDU: Transfer protocol data unit

3. SERVICES AND SERVICE ELEMENTS

The SMS provides a means to transfer short messages between a GSM MS and an SME via an SC. The SC serves as an interworking and relaying function of the message transfer between the MS and the SME.

This recommendation describes only the short message point-to-point services between the MS and SC. It may, however, refer to possible higher layer applications.

3.1 Basic services

The short message point-to-point services comprise two basic services:

SM MT (Short Message Mobile Terminated Point-to-Point),
SM MO (Short Message Mobile Originated Point-to-Point).

SM MT denotes the capability of the GSM system to transfer a short message submitted from the SC to one MS, and to provide information about the delivery of the short message either by a delivery report or a failure report with a specific mechanism for later delivery; see Figure 03.40/1.

SM MO denotes the capability of the GSM system to transfer a short message submitted by the MS to one SME via an SC, and to provide information about the delivery of the short message either by a delivery report or a failure report. The message must include the address of that SME to which the SC should eventually relay the short message; see Figure 03.40/2.

The text messages to be transferred by means of the SM MT or SM MO contain up to 140 octets.

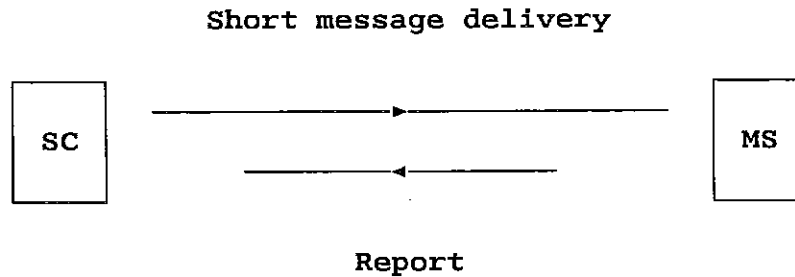

Figure 03.40/1 The Short Message Service mobile terminated, point-to-point.

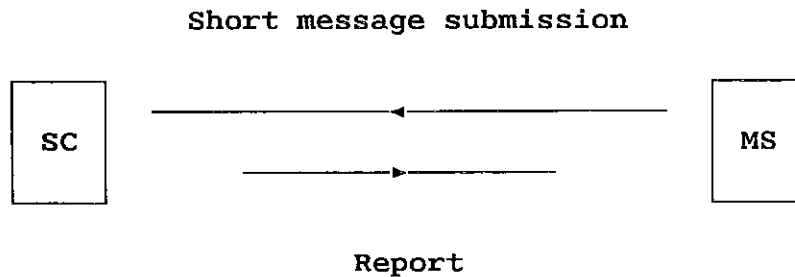

Figure 03.40/2 The Short Message Service mobile originated, point-to-point.

An active MS shall be able to receive a short message TPDU (SMS-DELIVER) at any time, independently of whether or not there is a speech or data call in progress. A report will always be returned to the SC; either confirming that the MS has received the short message, or informing the SC that it was impossible to deliver the short message TPDU to the MS, including the reason why.

An active MS shall be able to submit a short message TPDU (SMS-SUBMIT) at any time, independently of whether or not there is a speech or data call in progress. A report will always be returned to the MS; either confirming that the SC has received the short message TPDU, or informing the MS that it was impossible to deliver the short message TPDU to the SC, including the reason why.

Note: When the transmission or reception of a short message coincide with a change of state in the MS, i.e. from busy to idle or from idle to busy, or during a handover, the short message transfer might be aborted.

3.2 Short Message Service elements

The SMS comprises 7 elements particular to the submission and reception of messages:

- Validity-Period
- Service-Centre-Time-Stamp
- Protocol-Identifier
- More-Messages-to-Send
- Priority
- Messages-Waiting
- Alert-SC

3.2.1 Validity-Period

The Validity-Period is the information element which gives an MS submitting an SMS-SUBMIT to the SC the possibility to include a specific time period value in the short message (TP-Validity-Period field, see section 9). The TP-Validity-Period parameter value indicates the time period for which the short message is valid, i.e. for how long the SC should guarantee its existence in the SC memory before delivery to the recipient has been carried out.

3.2.2 Service-Centre-Time-Stamp

The Service-Centre-Time-Stamp is the information element by which the SC informs the recipient MS about the time of arrival of the short message at the SM-TL entity of the SC. The time value is included in every SMS-DELIVER (TP-Service-Centre-Time-Stamp field, see section 9) being delivered to the MS.

3.2.3 Protocol-Identifier

The Protocol-Identifier is the information element by which the SM-TL either refers to the higher layer protocol being used, or indicates interworking with a certain type of telematic device.

The Protocol-Identifier information element makes use of a particular field in the message types SMS-SUBMIT and SMS-DELIVER, TP-Protocol-Identifier (TP-PID).

3.2.4 More-Messages-to-Send

The More-Messages-to-Send is the information element by which the SC informs the MS that there is one or more messages waiting in that SC to be delivered to the MS. The More-Messages-to-Send information element makes use of a boolean parameter in the message SMS-DELIVER, TP-More-Messages-to-Send (TP-MMS).

3.2.5 Priority

Priority is the information element provided by an SC or SME to indicate to the PLMN whether or not a message is a priority message.

Delivery of a non-priority message will not be attempted if the MS has been identified as temporarily absent (see section 3.2.6).

Delivery of a priority message will be attempted irrespective of whether or not the MS has been identified as temporarily absent.

3.2.6 Messages-Waiting

The Messages-Waiting is the service element that enables the PLMN to provide the HLR and VLR with which the recipient MS is associated with the information that there is a message in the originating SC waiting to be delivered to the MS. The service element is only used in case of previous unsuccessful delivery attempt(s) due to temporarily absent mobile. This information, denoted the Messages-Waiting-Indication (MWI), consists of Messages-Waiting-Data (MWD) located in the HLR and the Messages-Waiting-Flag (MWF) located in the VLR, as depicted in Figure 03.40/3.

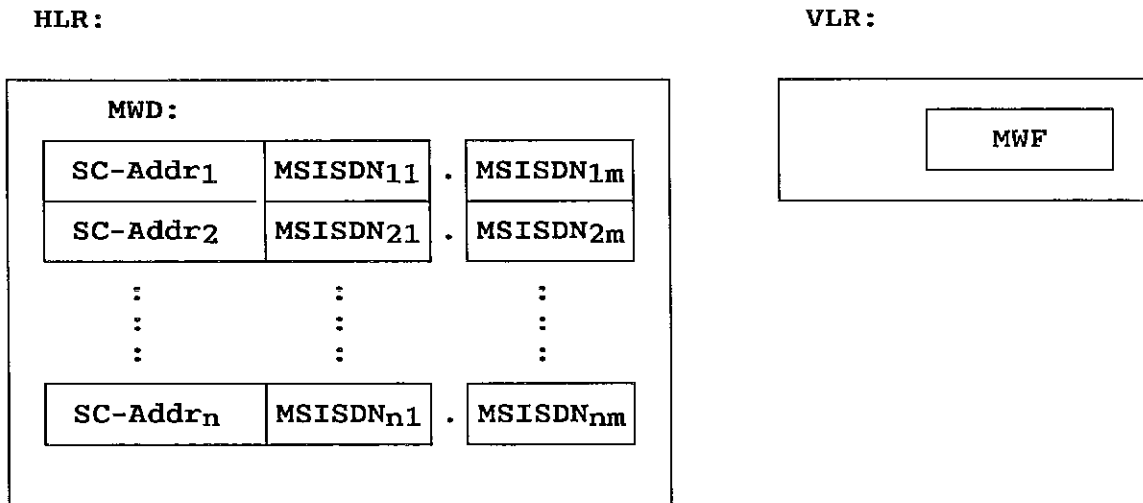

Figure 03.40/3. Structuring of the Messages-Waiting-Indication (MWI) in the HLR and VLR (example).

The MWD shall contain a list of addresses (SC-Addr) of SCs which have made previous unsuccessful delivery attempts of a message (see section 5). In order to link an alert message to an earlier delivery attempt in the multiple MSISDN scenario, the HLR shall store each SC address together with references to the MSISDN(s) used with the SMS-DELIVER(s). The requirements placed upon the HLR are specified in rec GSM 03.08. The description of how the HLR is provided with SC and MS address information is given in GSM 09.02.

The Messages-Waiting-Flag (MWF) within the VLR is a boolean parameter with the value FALSE when the list MWD is empty, and with the value TRUE when the list contains one or more list elements.

The MWD and MWF are updated in the following way:

- 1a. When a mobile terminated short message delivery fails due to the MS being temporarily absent (i.e. either IMSI DETACH flag is set or there is no response from the MS to a paging request), the SC address is inserted into the MWD list (if it is not already present) and the MWF is set (if it is not already set), as described in section 10.
2. When either the HLR or VLR detects that the MS (with a non-empty MWD in the HLR and the MWF set in the VLR) has recovered operation (e.g. has responded to a paging request), the HLR directly or on request of the VLR will invoke operations to alert the SCs within the MWD (see section 3.2.7 and section 10). Once the Alert SC operations have been invoked, the MWF is cleared. After each SC is alerted by the HLR, the address for that SC is deleted from the MWD.

3.2.7 Alert-SC

The Alert-SC is the service element, which may be provided by some GSM PLMNs, to inform the SC that an MS

- 1) to which there has been an unsuccessful delivery attempt and
- 2) which is now recognized by the PLMN to have recovered operation (e.g. to have responded to a paging request),

is again attainable. The SC may - on reception of an Alert-SC - initiate the delivery attempt procedure for the queued messages destined for this MS.

Where the mobile subscriber is identified by several MSISdn identities (i.e. several MSISdn identities are stored in the HLR), the Alert-SC shall provide the SC with the MSISdn identity used in the SMS-DELIVER.

If an SC has attempted to send more than one message to an MS using different MSISdns, then it shall receive one alert message per MSISdn used.

Note: Repeated delivery attempts from the SC may be of two types:

- i) A repeated delivery attempt because the SC has been informed that the MS is active and available to receive short messages.
- ii) An autonomous repeated delivery attempt by the SC.

The application of these two options is defined by the providers of the SC and the network.

3.2.8 Options concerning MWF and MWD

Setting the Messages-Waiting-Flag (MWF) in the VLR is mandatory. It is also mandatory for the VLR to send the 'MS Present' message (see section 10) to the HLR when the MS has been detected as becoming active and then to clear MWF.

The Messages-Waiting-Data (MWD) within the HLR is optional. This is linked to the transmission of the 'Alert SC' message.

The following describes what happens when a delivery fails.

Case 1: MWD is implemented in the HLR

In the case of a delivery failure (to an MS), the MSC requests the HLR to add, if needed, a new entry in the MWD. This new entry contains the SC address. The SC is notified of the failure and also of the MWD setting in the HLR within the Report message (see section 10).

If the HLR indicates that it is able to store the SC address, then the SC will receive an Alert SC message when the MS becomes active.

If the HLR indicates that it is unable to store the SC address (e.g. because MWD is full), then the only way to ensure delivery is for the SC to try to retransmit the message periodically.

When the HLR receives the MS Present message, it sends an Alert SC message to the concerned SC and updates MWD.

Case 2: MWD is not implemented in the HLR

In the case of a delivery failure, the SC is notified that the HLR is unable to store its address in the MWD. The SC must retransmit the short message periodically in order to ensure delivery.

The HLR discards the MS Present message received from the VLR without any failure or error report.

3.3 Unsuccessful short message TPDU transfer SC -> MS

Unsuccessful message transfer SC -> MS may be caused by a variety of different errors. The description of the occurrence of the different errors and how to handle and transfer the error indications is given in Rec. GSM 04.08, Rec. GSM 04.11 and Rec. GSM 09.02.

The different error indications which the SMS-GMSC shall be capable of returning to the SC following an unsuccessful short message TPDU transfer SC-> MS, is given in Table 03.40/1.

Error indication	S ¹)	Meaning
Unknown subscriber	P	The PLMN rejects the short message TPDU because there is not allocated an IMSI or a directory number for the mobile subscriber in the HLR (see Rec. GSM 09.02).
Teleservice not provisioned	P	The PLMN rejects the short message TPDU because the recipient MS has no SMS subscription (see Rec. GSM 09.02).
CUG reject	P	The PLMN rejects the short message TPDU due to the setting of the Closed User Groups (see Rec. GSM 09.02, and description of the Closed User Group supplementary service, Rec. GSM 02.04 and 03.11).
Call barred	T	The PLMN rejects the short message TPDU due to barring of the MS (see Rec. GSM 09.02, and description of the Barring supplementary service, Rec. GSM 02.04 and 03.11).
Facility not supported	T	The VPLMN rejects the short message TPDU due to no provision of the SMS in the VPLMN (see Rec. GSM 09.02).
Absent subscriber	T	The PLMN rejects the short message TPDU due to <ul style="list-style-type: none"> - no paging response, see Rec. GSM 04.08 - invocation of IMSI DETACH (see Rec. GSM 09.02), or - roaming restrictions (see 'Roaming not allowed', Rec. GSM 09.02).
SMS lower layers capabilities not provisioned	T	The PLMN rejects the short message TPDU due to MS not being able to support the Short Message Service. The short message transfer attempt is rejected either due to information contained in the class mark, or the MSC not being able to establish connection at SAPI = 3 (see Rec. GSM 04.08 and Rec. GSM 09.02).

1) : Status (Permanent or Temporary)

(Continued on next page)

(Continued from previous page)

Error indication	S1)	Meaning
Error in MS	T	The PLMN rejects the short message TPDU due to an error occurring within the MS at reception of a short message, e.g. lack of free memory capacity or protocol error.
System failure	T	The PLMN rejects the short message TPDU due to network or protocol failure others than those listed above (see Rec. GSM 09.02)

1) : Status (Permanent or Temporary)

Table 03.40/1. Error indications related to mobile terminated short message transfer which may be transferred to the originating SC.

The relation between the two sets of error indications is given in the table 03.40/1. Each error is classified as either 'Temporary' or 'Permanent'. This classification gives an indication of whether or not it is probable that the MS becomes attainable within a reasonable period, and so provides the recommended action to be taken by the SC, i.e. either to store the message for later transfer, or to discard it.

3.4 Unsuccessful short message TPDU transfer MS -> SC

The error indications related to mobile originated short message transfer which may be transferred to the originating MS are given in Rec. GSM 04.11.

3.5. Use of Supplementary Services in combination with the Short Message Service

Only a sub-set of the Supplementary Services defined in rec GSM 02.04 and 03.11 may be used in combination with the Short Message Service. This sub-set comprises thye following Supplementary Services:

- Closed User Group 1)
- Freephone service 1)
- Advice of Charge 1)
- All the 5 Barring services

1) For Further study.

4. Network architecture

4.1. Basic network structure

The exchange of messages between an MS and an SME involves the network entities shown in Figure 03.40/4.

The basic network structure of the SMS is depicted in Figure 03.40/5.

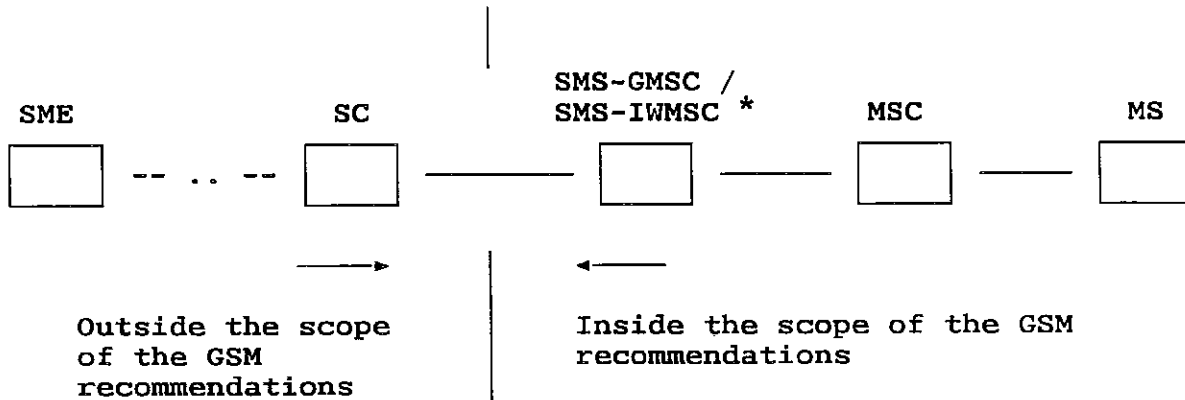

*): SMS-GMSC when the short message is transferred from the SC to the MS, SMS-IW MSC when the short message is transferred from the MS to the SC.

Figure 03.40/4. Entities involved in the provision of SM MT and SM MO: SC, SMS-GMSC/SMS-IW MSC, MSC and MS.

The links of Figure 03.40/5 support the short message transfer in the following way:

- message transfer on link 1 is described in section 5,
- the operations performed on links 2 and 4 is described in Rec. GSM 09.02,
- message transfer on link 3 is described in section 4.2,
- message transfer on link 5 is supported by protocol described in Rec. GSM 04.11.

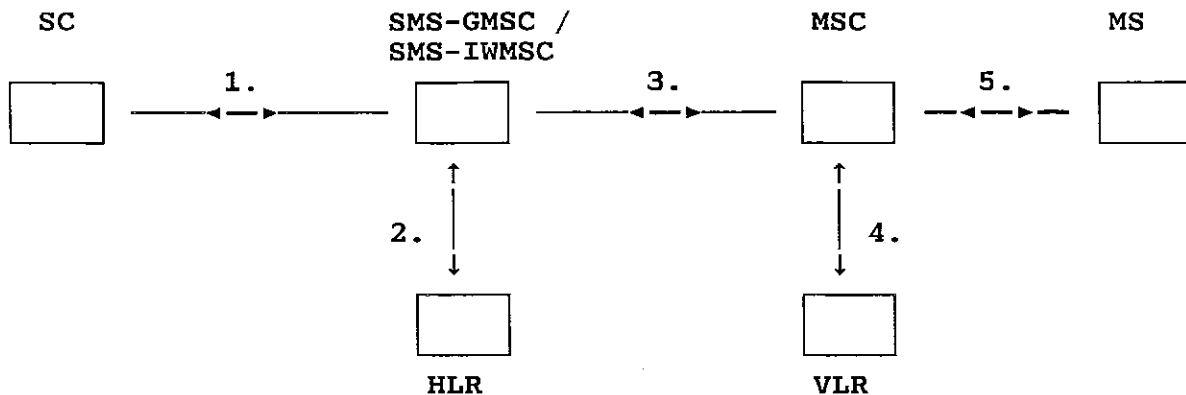

Figure 03.40/5. The main network structure serving as a basis for the short message transfer.

4.2 Transfer on link 3

The link 3 is used to support communications between MSCs (MSC, SMS-GMSC, SMS-IWMSC). Two cases can be distinguished according to whether or not the MSCs are located in the same PLMN.

In the first case the link definition is left to the operators. For example this link may use:

- PSPDN or
- SS no 7 (according to Rec. GSM 09.02).

In the second case SS no 7 shall be used over link 3 according to Rec. GSM 09.02, unless otherwise bilaterally agreed.

5. Service Centre and PLMN interconnection

This recommendation deals with the SC only with regard to the interchange of messages between SC and MS. As the SC (and any originating or terminating point for short messages beyond) is regarded as a node outside the PLMN, only the requirements put upon the SC by the SMS functionality are specified in this recommendation.

5.1 Service centre connection

One SC may be connected to several PLMNs, and may be connected to several MSCs (SMS-GMSCs or SMS-IWMSCs) within one and the same PLMN.

The SC is addressed from the mobile by an E.164 number in the numbering plan of the PLMN to which the SC is connected. This E.164 number shall uniquely identify the SC to that PLMN.

There may be an intermediate network between the PLMN and the SC; in this case the PLMN must autonomously make a connection to the SC using the SC address in this intermediate network.

No mandatory protocol between the SC and the MSC below the transfer layer is specified by GSM; this is a matter for agreement between SC and PLMN operators. However, Annex 1 provides an example protocol stack which could be used.

5.2 Routing requirements

5.2.1 Mobile terminated short message

The SC sends the short message to the SMS-GMSC. The SMS-GMSC interrogates the HLR to retrieve routing information necessary to forward the short message, and then sends the message to the relevant MSC, transiting other networks if necessary. The MSC then sends the short message to the MS.

5.2.2 Mobile originated short message

The MS sends the short message to the MSC. The MS will always address the required SC by an E.164 address. The visited PLMN will route the message to the appropriate SMS-IW MSC in the SC's PLMN, transiting other networks if necessary.

6. Service Centre functionality

In this recommendation, only the SC functionality related to the short message point-to-point service between the SC and the MS is specified.

6.1 Service Centre capabilities

The SC should be capable of

- submitting a short message to an MS, retaining the responsibility of the message until
 - 1) the report has been received, or
 - 2) the Validity-Period expires;
- receiving a report from the PLMN;
- receiving a short message from an MS;
- returning a report to the PLMN for a previously received short message.

6.2 SC functional requirements

The detailed functionality of the SC is outside the scope of this recommendation, and is for the SC operator to define. However, the following functional requirements are mandatory for all SCs in order to support the SM-TP (see section 9) towards the PLMN:

- 1) To identify each SMS-DELIVER sent to an MS in a unique way, a time stamp value is included in the field TP-Service-Centre-Time-Stamp, TP-SCTS, of the SMS-DELIVER. The time stamp gives the time when the message arrived at the SC with the accuracy of a second. If two or more messages to the same MS arrive at the SC within one second, the SC shall modify the time stamp of those messages in such a way that
 - a) all messages to the MS contain different time stamps
 - b) the modification of the time stamps is kept to a minimum.
- 2) The SC is only allowed to have one outstanding SMS-DELIVER (i.e. a message for which a report has not been received) to a specific MS at a given time.

7. MS functionality

In this recommendation, only the MS functionality related to the short message point-to-point service between the SC and the MS is specified.

7.1 MS capabilities

The MS, when equipped for SMS, should be capable of

- submitting a short message TPDU to an SC, retaining the responsibility of the message until
 - 1) the report arrives from the network, or
 - 2) a timer expires;
- receiving a short message TPDU from an SC;
- returning a delivery report to the network for a previously received short message;
- receiving a report from the network.

7.2 MS configuration

The reference configuration is assumed as in Figure 03.40/6, i.e. only the case where the terminal is integrated in the MS is considered.

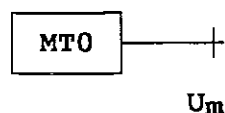

Figure 03.40/6. Reference configuration of the MS which apply to the SMS.

Note: It is foreseen that a terminal interface may be offered, e.g. for higher layer protocols, memory capacity reasons or to be able to type in mobile originated messages. This terminal interface is regarded as an implementation option, although, where offered, it must be based upon an R- or S-interface.

8. MSC functionality

The overall requirements to the MSC with respect to handling of the Short Message Service point-to-point is to cater for the routing and necessary intermediate buffering of the short messages.

8.1 MSC functionality related to SM MT

8.1.1 Functionality of the SMS-GMSC

When receiving a short message TPDU from the SC, the SMS-GMSC is responsible for the following operations:

- reception of the short message TPDU,
- inspection of the parameters,

(Note: The SMS-GMSC may be identical to the MSC),

if parameters are incorrect:

- returning the appropriate error information to the SC in a failure report (see section 9 and 10)

if errors are not found within parameters:

- interrogating the HLR ('sendRoutingInfoForShortMsg', see section 10); retrieving routing information or possible error information,

if HLR is returning error information:

- returning the appropriate error information to the SC in a failure report (see section 9 and 10)

if no errors are indicated by the HLR:

- transferring the short message TPDU to the MSC using the routing information obtained from the HLR ('forwardShortMessage', see section 10).

When receiving the report associated with the short message from the MSC (positive or negative outcome of 'forwardShortMessage', see section 10), the SMS-GMSC is responsible for the following operations:

if the report is a failure report indicating 'absent subscriber' (see section 3.3): requesting the HLR to insert the address of the originating SC into the MWD (if implemented) ('setMessageWaitingData', see section 9 and 10),

- establishing, where necessary, a link with the addressed SC (see section 5),
- creating and sending the report to the SC (see section 9 and 10).

8.1.2 Functionality of the MSC

When receiving a short message TPDU from the SMS-GMSC ('forwardShortMessage', see section 10), the MSC is responsible for the following operations:

- reception of the short message TPDU,
- retrieving information from the VLR ('sendInfoFor-IncomingCall', see section 10); location area address and, when appropriate, error information,

if errors are indicated by the VLR:

- returning the appropriate error information to the SMS-GMSC in a failure report (negative outcome of 'forwardShortMessage' see section 10),

if no errors are indicated by the VLR:

- transferring the short message to the MS (see Rec. GSM 04.11).

When receiving a confirmation that the message is received by the MS (see Rec. GSM 04.11):

- relaying the delivery confirmation to the SMS-GMSC in a delivery report (positive outcome of 'forwardShortMessage', see section 10).

When receiving an failure report of the short message transfer to the MS (see Rec. GSM 04.11):

- returning the appropriate error information to the SMS-GMSC in a failure report (negative outcome of 'forwardShortMessage', see section 10).

8.2 MSC functionality related to SM MO

8.2.1 Functionality of the MSC

When receiving a short message TPDU from the MS, the MSC is responsible for the following operations:

- reception of the short message TPDU 1) (see Rec. GSM 04.11)
- inspection of the parameters,
 - 1) : the reception of the short message TPDU is followed by the VLR in vestigating the MWF (to be used in the alerting procedure, see section 10)

if parameters are incorrect:

- returning the appropriate error information to the MS in a failure report (see Rec. GSM 04.11),

if no parameter errors are found:

- examination of the destination address,
(NOTE: The SMS-IWMSC may be identical to the MSC),
- transferring the short message TPDU to the SMS-IWMSC ('forwardShortMessage', see section 10).

When receiving the report of the short message from the SMS-IWMSC (positive or negative outcome of the 'forwardShortMessage', see section 10), the MSC is responsible for the following operations:

- relaying the report to the MS (see Rec. GSM 04.11).

8.2.2 Functionality of the SMS-IW MSC

When receiving a short message TPDU from the MSC ('forwardShortMessage', see section 10), the SMS-IW MSC is responsible for the following operations:

- reception of the short message TPDU,
- establishing, where necessary, a link with the addressed SC (see section 5),
- transferring the short message TPDU to the SC (if the address is valid).

If a report associated with the short message is received from the SC, the SMS-IW MSC is responsible for the following operations:

- relaying of the report to the MSC (positive or negative outcome of 'forwardShortMessage', see section 10).

If a report associated with the short message is not received from the SC before a timer expires or if the SC address is invalid, the SMS-IW MSC is responsible for the following operations:

- returning the appropriate error information to the MSC in a failure report (negative outcome of 'forwardShortMessage', see section 10).

The value of the timer is dependent on the protocol between the SC and the SMS-IW MSC.

8.3 SMS-IW MSC functionality related to alerting

When receiving an alert from the HLR ('alertServiceCentre', see section 10), the SMS-IW MSC is responsible for the following operations:

- inspect the SC address,
- generate an RP-Alert-SC (see section 9),
- transferring the RP-Alert-SC to the SC.

Note that if the SC address is not valid, then no further action will be taken.

9. Protocols and protocol architecture

The protocol layers of the SMS are structured as shown in Figure 03.40/7.

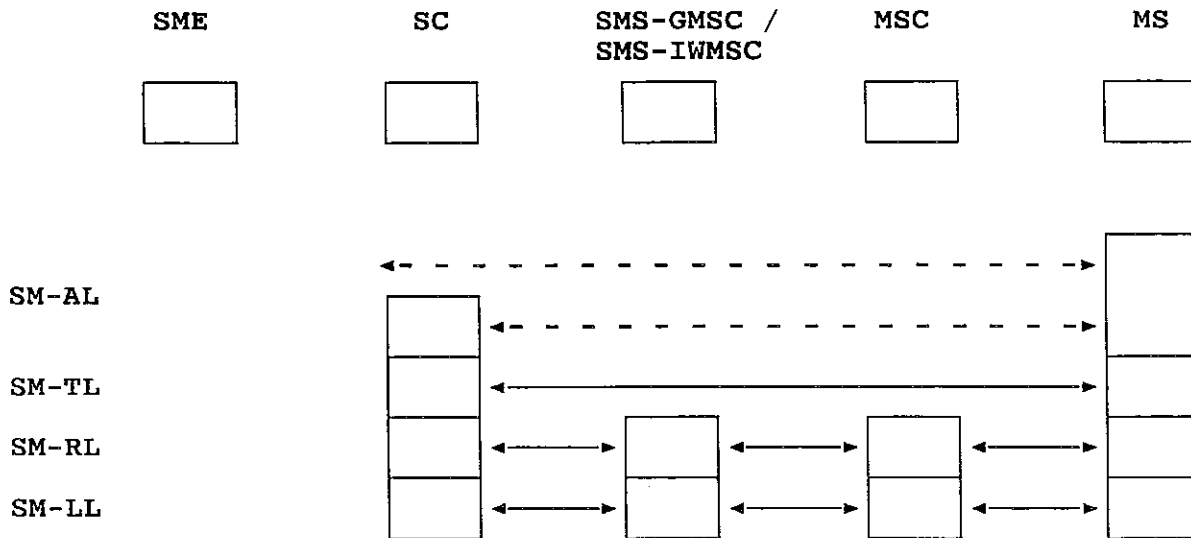

Figure 03.40/7 Protocol layer overview for the Short Message Service point-to-point.

This recommendation specifies the protocol at the SM-TL, the service offered by the SM-TL at the MS and the SC, and the service offered by the SM-RL at the SC.

9.1 Protocol element features

9.1.1 Octet and Bit transmission order

The octets are transmitted according to their individual numbering; the octet with the lowest number being transmitted first. The bits within each octet are transmitted according to their individual numbering also; the bits with the lowest internal number being transmitted first.

9.1.2 Numeric representation

For parameters within the TPDU's, there are three ways of numeric representation: Integer representation, octet and semi-octet representation.

9.1.2.1 Integer representation

Wherever the bits from a number of octets, complete or in fractions, are to represent an integer, the interpretation will be according to the following:

- 1) Between octets: The octets with the lowest octet numbers will contain the most significant bits.
- 2) Within an octet: The bits with the highest bit numbers will be the most significant.

Below is given an example of octet and bit representation and transmission order of an integer represented field.

Let the 2 rightmost bits of octet no 5, the complete octet no 6 and 7, and the 3 leftmost bits of octet no 8 represent an integer, as shown in Figure 03.40/8.

a)

	7	6	5	4	3	2	1	0
Oct.no.								
.								
5							5b1	5b0
6	6b7	6b6	6b5	6b4	6b3	6b2	6b1	6b0
7	7b7	7b6	7b5	7b4	7b3	7b2	7b1	7b0
8	8b7	8b6	8b5					
.

β)

5b1 5b0 6b7 6b66b1 6b0 7b7 7b67b1 7b0 8b7 8b6 8b5

Γ)

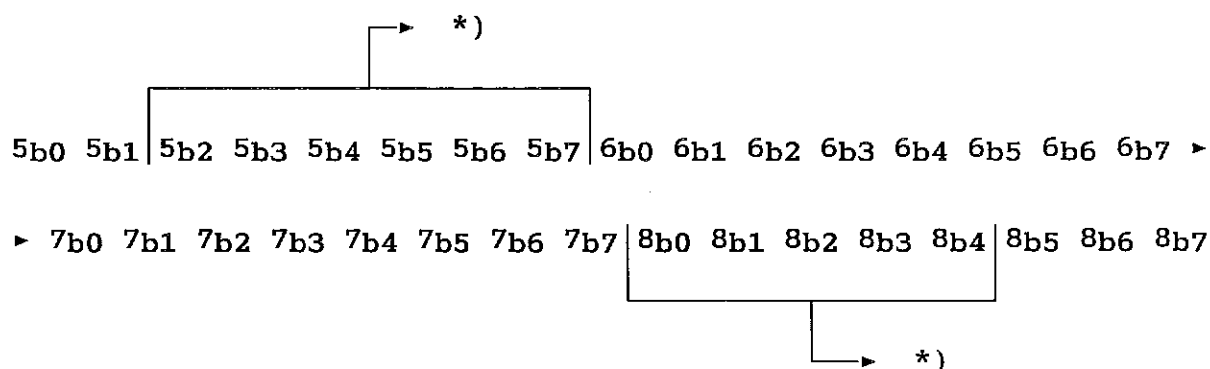

*) : Bits not representing the integer.

Figure 03.40/8. 21 bits from the octets 5, 6, 7, and 8 in a short message a) will represent an integer as shown in β), and will be transmitted in an order as shown in Γ).

9.1.2.2 Octet representation

A field which is octet represented, will always consist of a number of complete octets. Each octet within the field represent one decimal digit. The octets with the lowest octet numbers will contain the most significant decimal digits.

9.1.2.3. Semi-octet representation

A field which is semi-octet represented, will consist of a number of complete octets and - possibly - one half octet. Each half octet within the field represent one decimal digit. The octets with the lowest octet numbers will contain the most significant decimal digits. Within one octet, the half octet containing the bits with bit numbers 0 to 3, will represent the most significant digit.

In the case where a semi-octet represented field comprises an odd number of digits, the bits with bit numbers 4 to 7 within the last octet are fill bits and should always be set to '1111'.

Below is given an example:

Octet no:

n+1	Digit 2	Digit 1
n+2	Digit 4	Digit 3
n+3	1 1 1 1	Digit 5

9.1.2.4 Address fields

Each address field of the SM-TL and SM-RL consists of the following sub-fields: An Address-Length field of one octet, a Type-of-Address field of one octet, and one Address-Value field of variable length; as shown below:

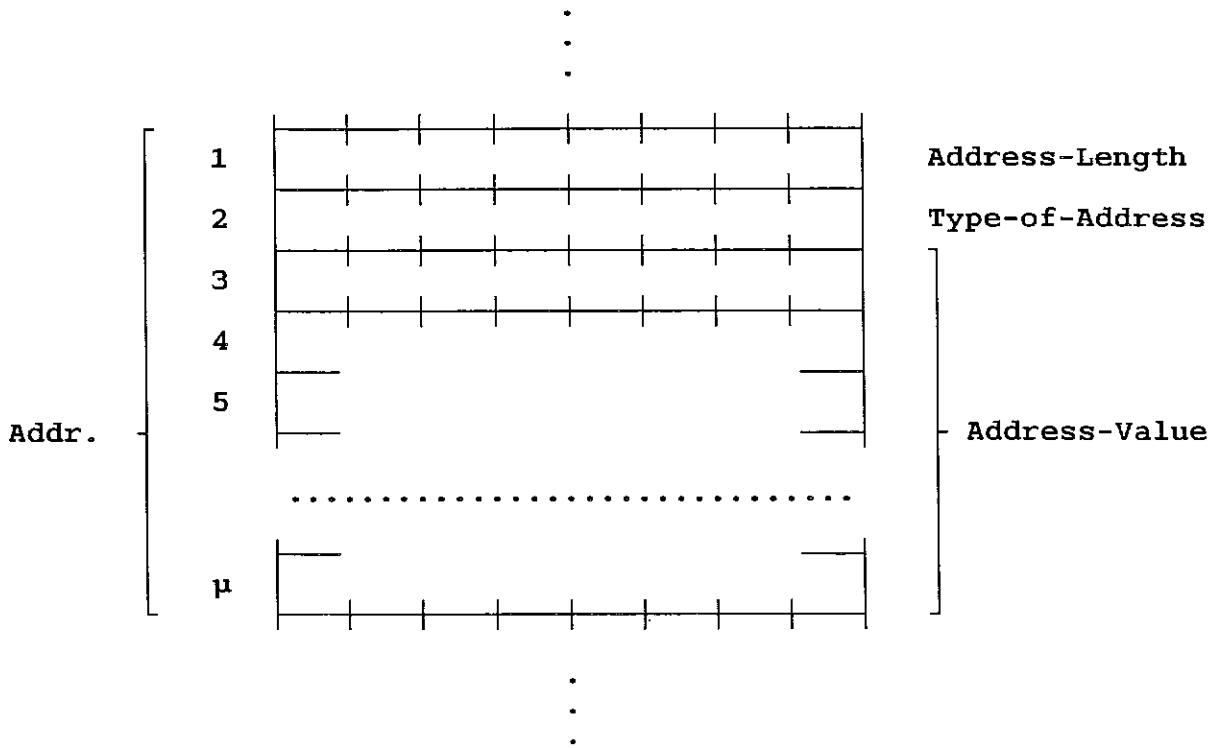

The Address-Length field indicates the number of decimal digits within the Address-Value field.

The Type-of-Address field format is as follows:

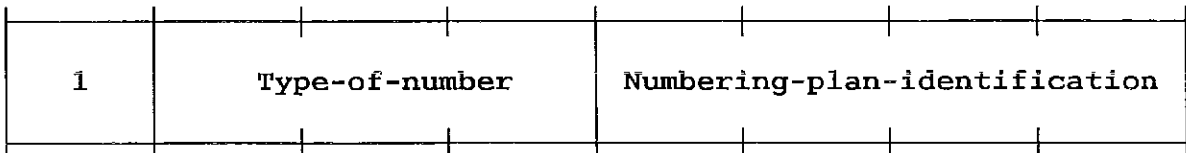

Type-of-number:

Bits	6	5	4	
	0	0	0	Unknown ¹
	0	0	1	International number ²
	0	1	0	National number ³
	0	1	1	Network specific number ⁴
	1	0	0	Short number ⁵
	1	0	1	} Not specified
	to			
	1	1	1	

- 1) : 'Unknown' is used when the user or network has no a priori information about the numbering plan. In this case, the Address-Value field is organized according to the network dialling plan, e.g. prefix or escape digits might be present.
- 2) : The international format shall be accepted also when the message is destined to a recipient in the same country as the MSC.
- 3) : Prefix or escape digits shall not be included.
- 4) : 'Network specific number' is used to indicate administration/service number specific to the serving network, e.g. used to access an operator.
- 5) : 'Short number' is used when a specific short number representation is stored in one or more SCs as part of a higher layer application. (Note that 'Short number' shall only be used in connection with the proper PID referring to this application).

Numbering-plan-identification (applies for Type-of-number = 000,001,010)

Bits	3 2 1 0	
	0 0 0 0	Unknown
	0 0 0 1	ISDN / telephone numbering plan (CCITT Rec E.164/E.163)
	0 0 1 1	Data numbering plan (CCITT Rec.X.121)
	0 1 0 0	Telex numbering plan
	1 0 0 0	National numbering plan
	1 0 0 1	Private numbering plan
	1 1 1 1	Reserved for extension

All other values are unspecified.

Note that for addressing any of the entities SC, MSC or MS, Numbering-plan-identification = 0001 will always be used. However, for addressing the SME, any specified Numbering-plan-identification value may be used.

Within the Address-Value field, a semi-octet representation applies.

The maximum length of the full address field (Address-Length, Type-of-Address and Address-Value) is 12 octets.

9.2 Service provided by the SM-TL

9.2.1 General

This section defines the service provided by SM-TL to offer Short Message Service to the SM-AL in the MS or SC. The service description includes:

- The service definition
- The definition of the primitives

- The definition of the parameters of the primitives and the options attached to the parameters
- The definition of the protocol elements
- The definition of the parameters of the protocol elements
- A description of what SM-TL has to provide (in the MS and in the SC) when receiving or issuing primitives.

9.2.2 Service definition

The service which SM-TL offers to SM-AL in the SM MT and SM MO cases is shown in Figure 03.40/9.

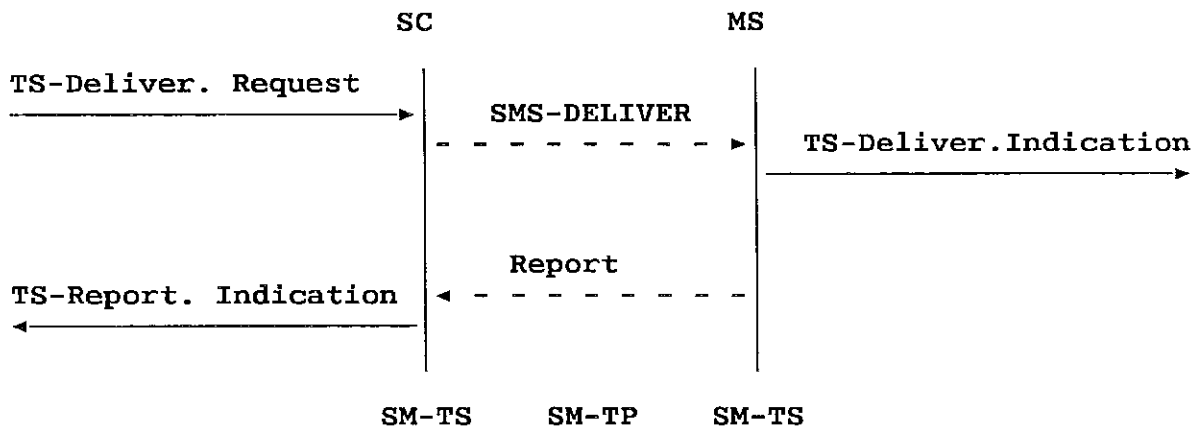

a) The SM MT case

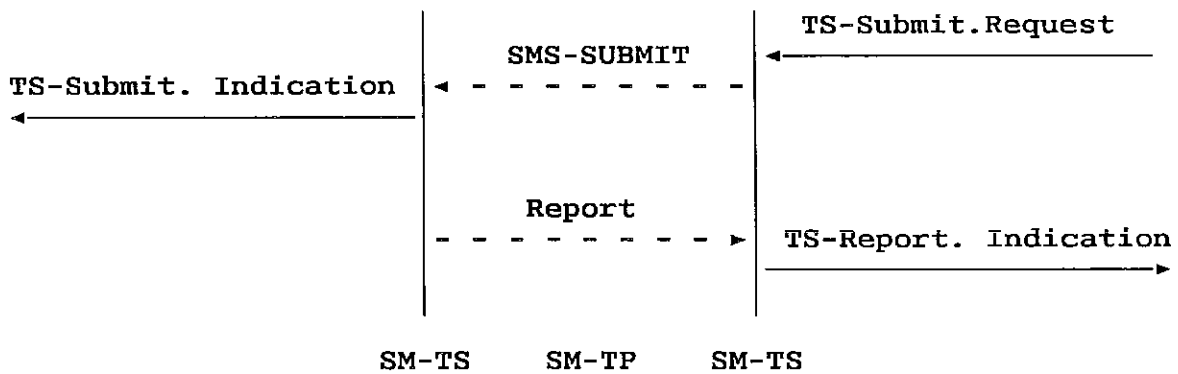

b) The SM MO case

Figure 03.40/9. Relationship between SM-TS primitives and TPDUs.

Note: Whereas SMS-DELIVER and SMS-SUBMIT are TPDUs, the report is a piece of information carried in the RP-ACK or RP-ERROR (see section 9.3.5).

9.2.3 Definition of primitives

This section describes the primitives of service and associated parameters provided by the SM-TL.

9.2.3.1 TS-Deliver

Parameter	TS-Deliver 1)	
	Request	Indication
TS-Short-Message-Identifier	M	M
TS-Destination-Address	M	-
TS-Originating-Address	M	M
TS-Service-Centre-Address	M	M
TS-Protocol-Identifier	M	M
TS-Data-Coding-Scheme	O	O
TS-More-Messages-to-Send	-	O 2)
TS-Service-Centre-Time-Stamp	-	M
TS-Priority	O	-
TS-Short-Message-Information	M	M

Note 1 : Provision: Mandatory (M), Optional (O) or Not present (-)

Note 2 : The TS-More-Messages-to-Send parameter may be present in a TS-Deliver.Indication issued by the SM-TL at the MS.

TS-Deliver.Request is used by the SM-AL entity of the SC to send a short message.

When the SM-TL receives this primitive, SM-TL forms a SMS-DELIVER element of protocol and sends it to the SM-RL in a RS-MT-Data.Request.

TS-Deliver.Indication is sent by SM-TL entity to SM-AL entity of MS when receiving the SMS-DELIVER element of protocol.

9.2.3.2 TS-Report

Parameter	TS-Report 1)
	Indication
TS-Short-Message-Identifier	0 2)
TS-Status-of-Report	M
TS-Messages-Waiting-Set	0 3)

Note 1 : Provision: Mandatory (M) or Optional (O)

Note 2 : In certain error conditions (e.g. local failure) the TS-Short-Message-Identifier parameter may not be present (see description below of 'Abnormal situation').

Note 3 : The TS-Messages-Waiting-Set parameter may be present in a TS-Report.Indication issued by the SM-TL at the SC.

TS-Report.Indication is used by SM-TL to provide a local acknowledgement or failure report.

- Case I: Normal Situation

The TS-Status-of-Report parameter indicates successful transfer and the TS-Short-Message-Identifier parameter allows to link this report to a previous TS-Deliver.Request or TS-Submit.Request. SM-TL sends this primitive when receiving the RS-Report.Indication.

- Case II: Abnormal Situation

1. When receiving the RS-Error.Indication, the SM-TL sends a TS-Report.Indication with a TS-Status-of-Report parameter specifying the failure. The TS-Status-of-Report parameter takes the value of the RS-Cause parameter. At the SC side, the TS-Messages-Waiting-Set parameter is only set if the RS-Messages-Waiting-Set is set itself, otherwise this parameter is not present in the primitive.

This is performed when SM-TL is able to link the received primitive to a previously received TS-Submit.Request or TS-Deliver.Request.

2. When the SM-TL is unable to link the RS-Error.Indication to a previous interaction (TS-Submit.Request or TS-Deliver.Request), the received message is discarded. In this case, SM-TL will wait for expiry of the timer in order to send the TS-Report.Indication with a TS-Status-of-Report parameter having the value 'Timer expiry'.
3. When a failure occurs locally at the SM-TL, the following two cases have to be taken into account:

- SM-TL is able to link this failure to a previous interaction. In this case, the TS-Report.Indication gives the TS-Short-Message-Identifier parameter for which the failure has occurred.
- SM-TL is unable to link this failure to a previous interaction. In this case, the TS-Report.Indication does not contain any TS-Short-Message-Identifier, and the TS-Status-of-Report parameter shall give information on the local failure.

9.2.3.3 TS-Submit

Parameter	TS-Deliver 1)	
	Request	Indication
TS-Short-Message-Identifier	M	M
TS-Destination-Address	M	M
TS-Service-Centre-Address	O 2)	-
TS-Originating-Address	-	M
TS-Protocol-Identifier	M	M
TS-Data-Coding-Scheme	O	O
TS-Validity-Period	O	O
TS-Short-Message-Information	M	M

Note 1 : Provision: Mandatory (M), Optional (O) or Not present (-)

Note 2 : May be omitted if a default SC address resides within the SM-TL entity of the MS.

TS-Submit.Request is used by the SM-AL entity of the MS to send a short message.

When the SM-TL receives this primitive, the SM-TL forms a SMS-SUBMIT element of protocol and sends it to the SM-RL in a RS-MO-Data.Request (see section 9.3).

TS-Submit.Indication is sent by the SM-TL entity to the SM-AL entity of the SC when receiving the SMS-SUBMIT element of protocol.

9.2.4 Definition of parameters

9.2.4.1 TS-Short-Message-Identifier

TS-Short-Message-Identifier links a TS-Report to a previous TS-Deliver or TS-Submit. A TS-Short-Message-Identifier cannot be re-used during a certain period (the frozen period) in order to ensure that all the reports (normal or not) have arrived. TS-Short-Message-Identifier is local to the MS or the SC.

9.2.4.2 TS-Destination-Address

TS-Destination-Address defines the address of the destination entity. When TS-Destination-Address is included in a primitive issued by the SC, it contains the MSISdn of the recipient MS. When TS-Destination-Address is included in a primitive issued by the MS, it contains the SME address.

9.2.4.3 TS-Originating-Address

TS-Originating-Address defines the address of the originating entity. When TS-Originating-Address is included in a primitive issued by the SC, it contains the SME address. When TS-Originating-Address is included in a TS-submit, it contains the MSISdn.

9.2.4.4 TS-Service-Centre-Address

TS-Service-Centre-Address defines the address of the SC. The TS-Service-Centre-Address will always be an E.164 address, see section 5.

9.2.4.5 TS-Protocol-Identifier

The TS-Protocol-Identifier parameter refers to the protocol of the SM-AL or the telematic interworking; see section 3.2.3.

9.2.4.6 TS-Data-Coding-Scheme

The TS-Data-Coding-Scheme parameter refers to the coding used for the short message.

9.2.4.7 TS-Service-Centre-Time-Stamp

The TS-Service-Centre-Time-Stamp parameter contains the time stamp given by the SC to be included in each short message delivered to an MS, see section 3.2.2.

9.2.4.8 TS-Messages-Waiting-Set

The TS-Messages-Waiting-Set parameter is used to indicate to the SM-AL entity within the SC that the MS is not attainable and that the SC address has been included in the MWD list in the HLR, see section 3.2.5.

9.2.4.9 TS-Priority

The TS-Priority parameter is used by the SM-AL entity within the SC to indicate to the network whether or not a message transfer attempt shall be carried out in the case that the MWD list in HLR is not empty, see section 3.2.6.

9.2.4.10 TS-Status-of-Report

The TS-Status-of-Report parameter is an information provided to the SM-AL which defines the report either as a delivery report or as a failure report.

The value associated with this parameter is one of the following:

- an acknowledgement (in case of delivery report)
- a failure report given by the SM-RL within the RS-Error.Indication primitive. In this case the TS-Status-of-Report is equivalent to the RS-Status-of-Report.
- a failure report generated locally by the SM-TL in case of local failure. In this case, the SM-TL may not be able to link the failure report with a previous TS-Deliver.Request or TS-Submit.Indication.

9.2.4.11 TS-More-Messages-to-Send

The TS-More-Messages-to-Send parameter informs the MS that one or more messages are waiting in the SC to be delivered to the MS (see section 3.2.4).

9.2.4.12 TS-Validity-Period

The TS-Validity-Period parameter indicates the time period for which the short message is valid i.e. the time period during which the SC should keep the short message in case the SME is temporarily out of operation (see section 3.2.1).

9.2.4.13 TS-Short-Message-Information

This parameter contains the length and the data associated with the short message.

9.2.5 PDU Type repertoire at SM-TL

The SM-TL comprises the following two PDUs:

- SMS-DELIVER, conveying a short message from the SC to the MS
- SMS-SUBMIT, conveying a short message from the MS to the SC.

9.2.5.1 SMS-DELIVER type

Abbr.	Reference	P1)	R2)	Description
TP-MTI	TP-Message-Type-Indicator	M	I	Parameter describing the message type.
TP-MMS	TP-More-Messages-to-Send	M	I	Parameter indicating whether or not there are more messages to send
TP-OA	TP-Originating-Address	M	I/S	Address of the originating SME.
TP-PID	TP-Protocol-Identifier	M	I	Parameter identifying the above layer protocol, if any
TP-DCS	TP-Data-Coding-Scheme	M	I	Parameter identifying the coding scheme within the TP-User-Data.
TP-SCTS	TP-Service-Centre-Time-Stamp	M	S	Parameter identifying time when the SC received the message.
TP-UDL	TP-User-Data-Length	M	I	Parameter indicating the length of the TP-User-Data field to follow.
TP-UD	TP-User-Data	M	3)	

1) : Provision; Mandatory (M) or Optional (O).

2) : Representation; Integer (I), Semi-octet (S) or Octet (O) representation

3) : Dependent on the TP-DCS

Layout of SMS-DELIVER:

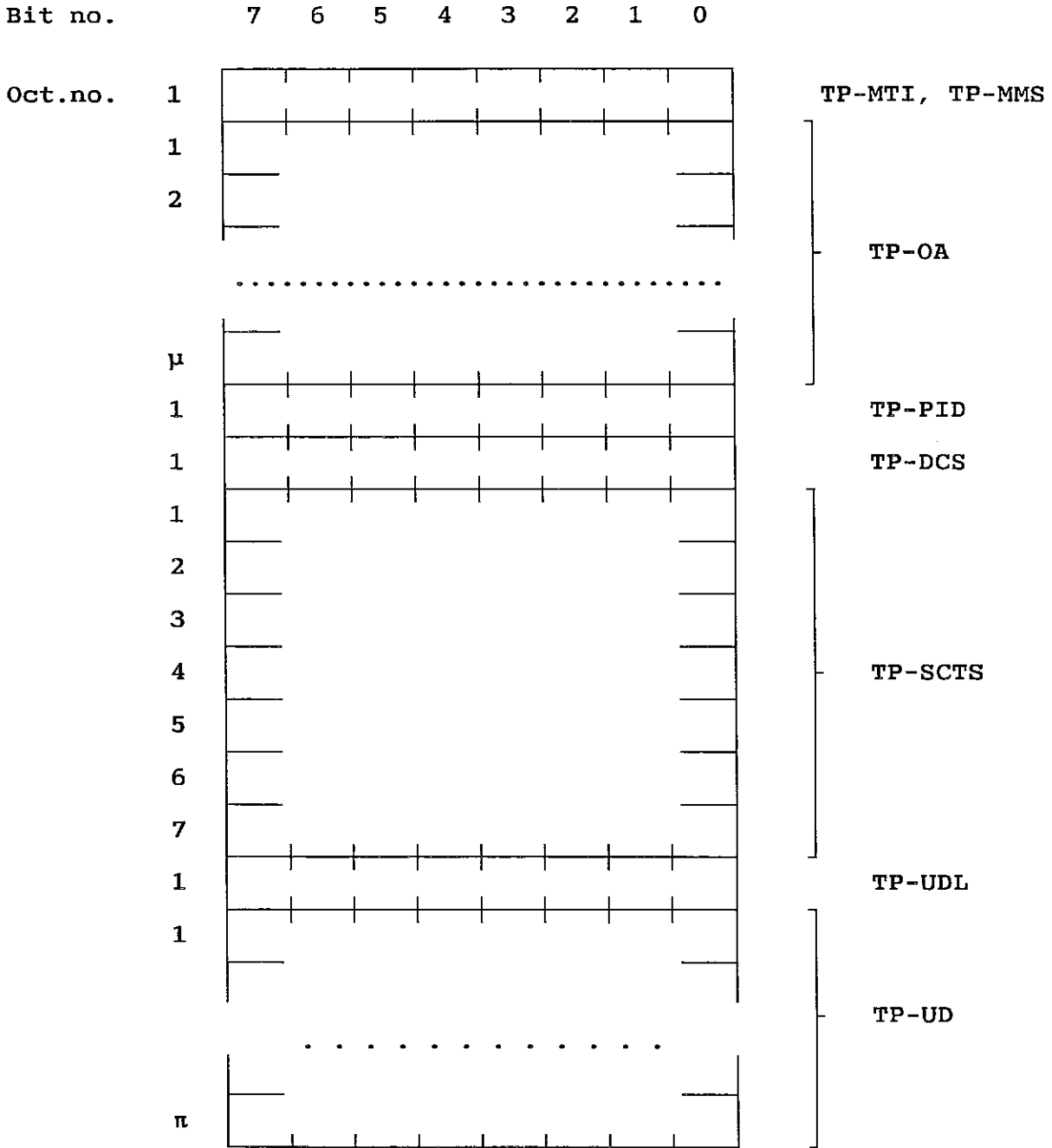

9.2.5.2. SMS-SUBMIT type

Basic elements of the SMS-SUBMIT type:

Abbr.	Reference	p1)	R2)	Description
TP-MTI	TP-Message-Type-Indicator	M	I	Parameter describing the message type.
TP-VPF	TP-Validity-Period-Format	M	I	Parameter indicating whether or not the TP-VP field is present.
TP-MR	TP-Message-Reference	M	I	Parameter identifying the SMS-SUBMIT.
TP-DA	TP-Destination-Address	M	I/S	Address of the destination SME.
TP-PID	TP-Protocol-Identifier	M	I	Parameter identifying the above layer protocol, if any
TP-DCS	TP-Data-Coding-Scheme	M	I	Parameter identifying the coding scheme within the TP-User-Data.
TP-VP	TP-Validity-Period	O	I/S	Parameter identifying the time from where the message is no longer valid.
TP-UDL	TP-User-Data-Length	M	I	Parameter indicating the length of the TP-User-Data field to follow.
TP-UD	TP-User-Data	M	3)	

1) : Provision; Mandatory (M) or Optional (O).

2) : Representation; Integer (I), Semi-octet (S) or Octet (O) representation

3) : Dependent on the TP-DCS

Layout of SMS-SUBMIT:

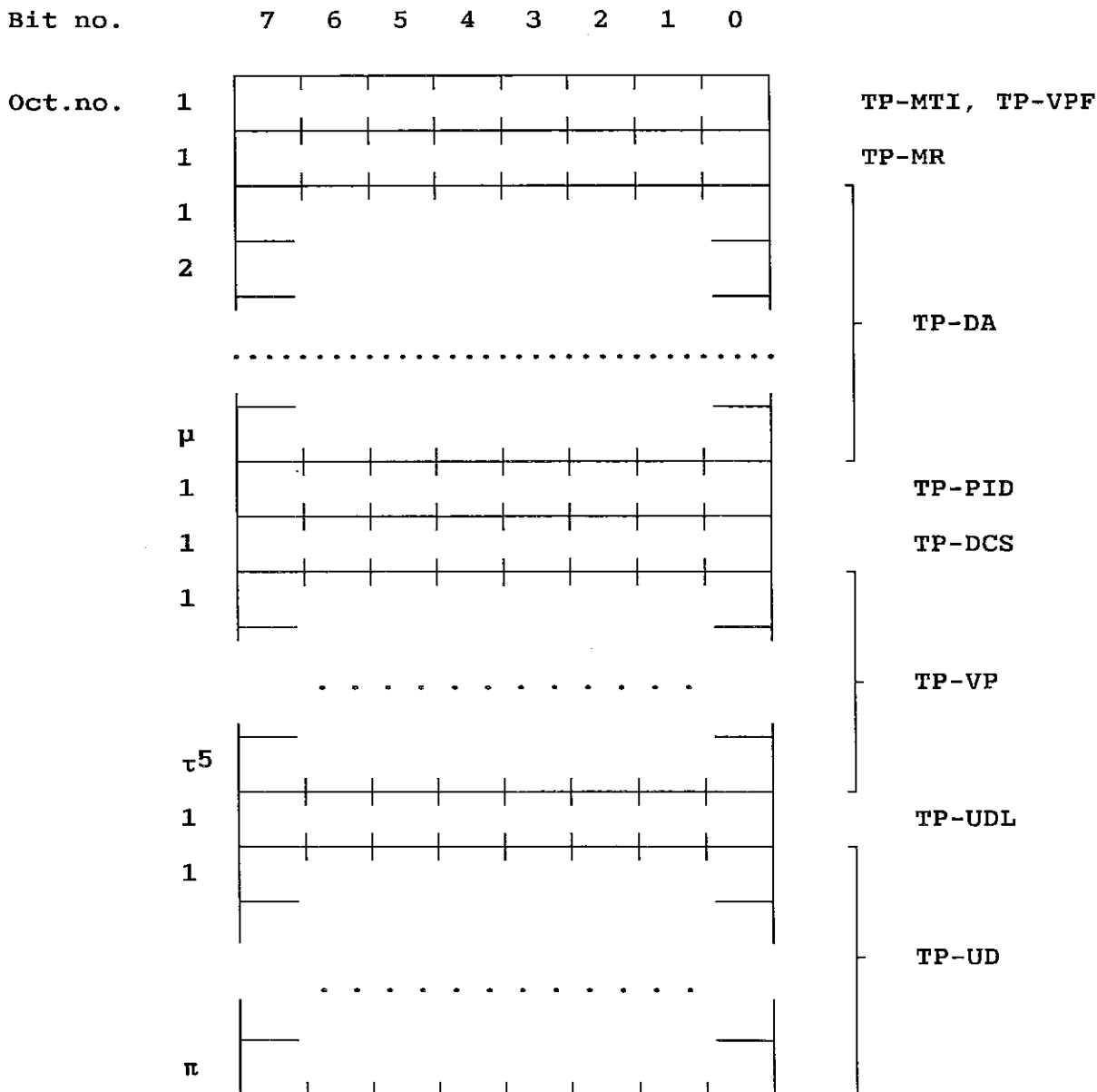

5) : τ is either 1 or 7, see below.

9.2.6. Definition of the TPDU parameters

9.2.6.1. TP-Message-Type-Indicator (TP-MTI)

The TP-Message-Type-Indicator is a 1-bit field, located within bit no 0 of the first octet of SMS-DELIVER or SMS-SUBMIT, and to be given the following values:

Bit no 0: 0 Message type: SMS-DELIVER
 1 Message type: SMS-SUBMIT

9.2.6.2. TP-More-Messages-to-Send (TP-MMS)

The TP-More-Messages-to-Send is a 1-bit field, located within bit no 2 of the first octet of SMS-DELIVER, and to be given the following values:

Bit no 2: 0 More messages are waiting for the MS in this SC
 1 No more messages are waiting for the MS in this SC

9.2.6.3. TP-Validity-Period-Format (TP-VPF)

The TP-Validity-Period-Format is a 2-bit field, located within bit no 3 and 4 of the first octet of SMS-SUBMIT, and to be given the following values:

Bit no 3,4: 00 TP-VP field not present
 01 TP-VP field present and integer represented
 (relative)
 10 Spare
 11 TP-VP field present and semi-octet represented
 (absolute)

9.2.6.4. TP-Message-Reference (TP-MR)

The TP-Message-Reference field gives an integer representation of a reference number of the SMS-SUBMIT submitted to the SC by the MS. The MS increments TP-Message-Reference by 1 for each SMS-SUBMIT being submitted. The reference number may possess values in the range 0 to 255.

9.2.6.5. TP-Originating-Address (TP-OA)

The TP-Originating-Address field is formatted according to the formatting rules of address fields.

9.2.6.6. TP-Destination-Address (TP-DA)

The TP-Destination-Address field is formatted according to the formatting rules of address fields.

9.2.6.7. TP-Protocol-Identifier (TP-PID)

The TP-Protocol-Identifier parameter serves the purposes indicated in section 3.2.3. It consists of one octet, and the bits in the octet are used as follows:

<u>bits</u>	<u>usage</u>
7...6	reserved (to be sent with zero value)
5	indicates telematic interworking: value = 0 : no interworking, but SME-to-SME protocol value = 1 : telematic interworking
4...0	in case of SME-to-SME protocol, (bit 5 = 0) identify the SM-AL protocol between the SMEs; in case of telematic interworking, (bit 5 = 1) indicate the type of the telematic device as specified below.

In case of telematic interworking, the following five bit patterns in bits 4...0 are used to indicate different types of telematic devices:

00000	implicit - device type is specific to this SC, or can be concluded on the basis of the address
00001	telex (or teletex reduced to telex format)
00010	group 3 telefax
00011	group 4 telefax
00100	voice telephone (i.e. conversion to speech)
00101...00111	(reserved, 3 combinations)
01000	teletex, carrier unspecified
01001	teletex, in PSPDN
01010	teletex, in CSPDN
01011	teletex, in analog PSTN
01100	teletex, in digital ISDN
01101...01111	(reserved, 3 combinations)
10000	a message handling facility (known to the SC)
10001	any public X.400-based message handling system
10010...10111	(reserved, 6 combinations)
11000...11110	values specific to each SC, usage based on mutual agreement between the SME and the SC (7 combinations available for each SC)
11111	an MS - the SC converts the SM from the present TP-Data-Coding-Scheme supported by that MS (e.g. the default).

If bit 5 has value 1 in an SMS-SUBMIT PDU, it indicates that the SME is a telematic device of a type which is indicated in bits 4...0, and requests the SC to convert the SM into a form suited for that device type. If the destination network is ISDN, the SC must also select the proper service indicators for connecting to a device of that type.

If bit 5 has value 0 in an SMS-SUBMIT PDU, the SC may deliver the SM unmodified to the SME. Bits 4...0 will then identify the SM-AL protocol to the SME.

If bit 5 has value 1 in an SMS-DELIVER PDU, it indicates that the SME is a telematic device of a type which is indicated in bits 4...0.

If bit 5 has value 0 in an SMS-DELIVER PDU, the value in bits 4...0 identifies the SM-AL protocol being used between the SME and the MS.

Note that for the straightforward case of simple MS-to-SC or SC-to-MS short message transfer the Protocol Identifier field is set to the value 0.

9.2.6.8. TP-Data-Coding-Scheme (TP-DCS)

The TP-Data-Coding-Scheme field indicates the data coding scheme of the TP-UD field. The TP-Data-Coding-Scheme may possess integer values in the range 0 to 255.

The default value 0 indicates that the TP-UD consists of alphabet given in Annex 2, without parity, and shall be supported by all MSs and SCs offering the service.

The characters of the message are packed in octets as precised in Annex 2, and consist of up to 160 characters.

Other values are reserved, but if these are allocated, they shall be additional to the default value.

9.2.6.9. TP-Service-Centre-Time-Stamp (TP-SCTS)

The TP-Service-Centre-Time-Stamp field is given in semi-octet representation, and represents the time in the following way:

	Year	:	Month	:	Day	:	Hour	:	Minute	:	Second	:	Time Zone
Digits:	2		2		2		2		2		2		2
	(Semi-octets)												

The Time Zone indicates the difference, expressed in quarters of an hour, between the local time and the GMT. In the first of the two semi-octets, the first bit (bit 7 of the seventh octet of the TP-Service-Centre-Time-Stamp field) represents the algebraic sign of this difference (0 : positive, 1 : negative). Negative numbers will use the two's complement representation. The Time Zone may be a number in the range -47 to +48.

9.2.6.10. TP-Validity-Period

The TP-Validity-Period field is given in either integer or semi-octet representation. In the first case, the TP-Validity-Period comprises 1 octet, giving the length of the validity period, counted from when the SMS-SUBMIT is received by the SC. In the second case, the TP-Validity-Period comprises 7 octets, giving the absolute time of the validity period termination.

In the first case, the representation of time is as follows:

TP-VP value	Validity period value
0 to 143	$(TP-VP + 1) \times 5$ minutes (i.e. 5 minutes intervals up to 12 hours)
144 to 167	12 hours + $((TP-VP - 143) \times 30)$ minutes
168 to 196	$(TP-VP - 166) \times 1$ day
197 to 255	$(TP-VP - 192) \times 1$ week

In the second case, the representation of time is identical to the representation of the TP-Service-Centre-Time-Stamp.

9.2.6.11. TP-User-Data-Length (TP-UDL)

The TP-User-Data-Length field gives an integer representation of the number of characters within the TP-User-Data field to follow.

9.3. Service provided by the SM-RL

9.3.1. General

This section describes the primitives of service and associated parameters provided by the SM-RL and used by the SM-TL to offer the Short Message Service to the SC and the MS on the link 1 (see Figure 03.40/5).

The service description includes:

- The service definition
- The definition of the primitives
- The definition of the parameters of the primitives and the options attached to the parameters
- The definition of the protocol elements
- The definition of the parameters of the protocol elements
- A description of what SM-RL has to provide (in the MS and in the SC) when receiving or issuing primitives.

9.3.2. Service definition

Rec. GSM 04.11 defines the service provided by SM-RL in the MS. The figures 03.40/10 to 03.40/13 only give an overview of message exchange between SC and MS. If discrepancies exist in nomenclature at the MS side, it is the Rec. GSM 04.11 that will be the reference.

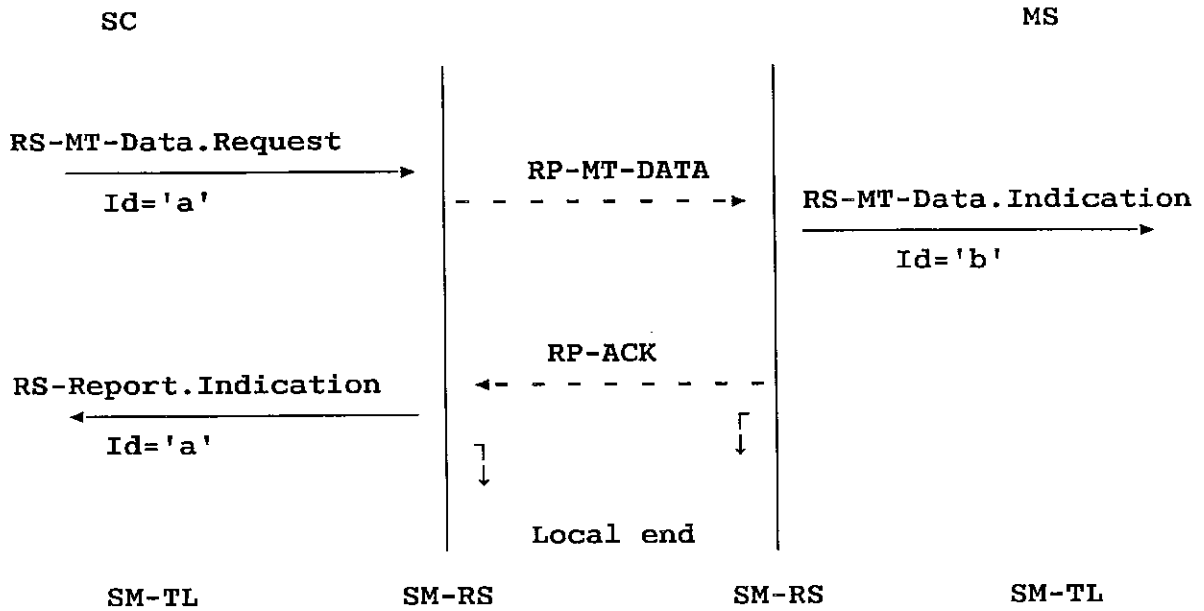

Figure 03.40/10a. Relationship between SM-RS primitives and relay layer protocol elements in the SM MT case.

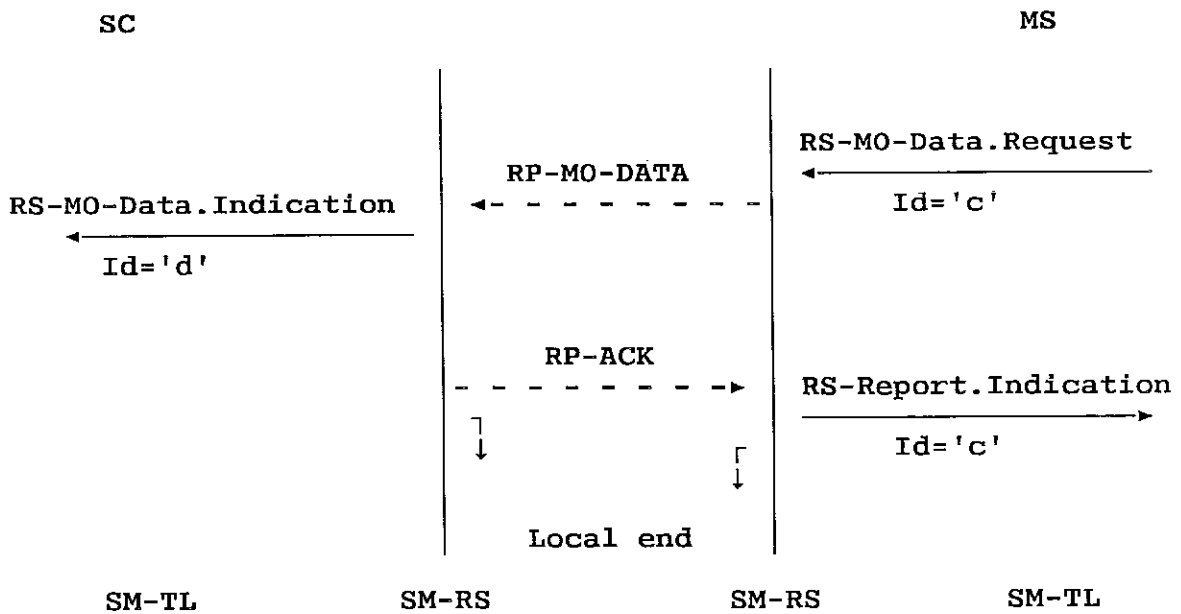

Figure 03.40/10b. Relationship between SM-RS primitives and relay layer protocol elements in the SM MO case.

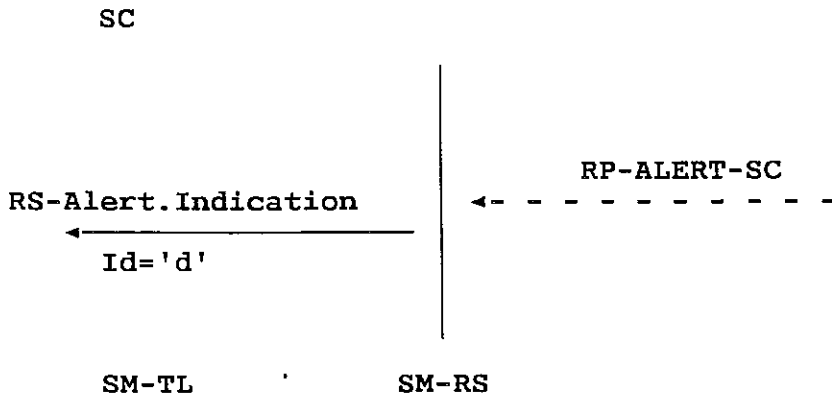

Figure 03.40/11. Relationship between SM-RS primitives and relay layer protocol elements in the Alert case.

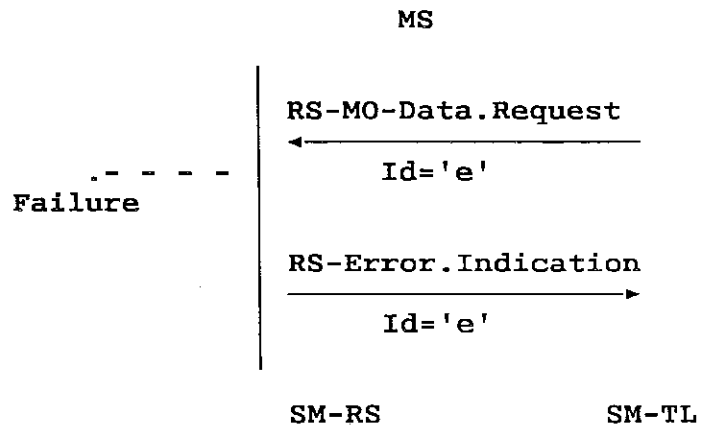

Figure 03.40/12a. Error Service (Mobile originated short message transfer attempt)

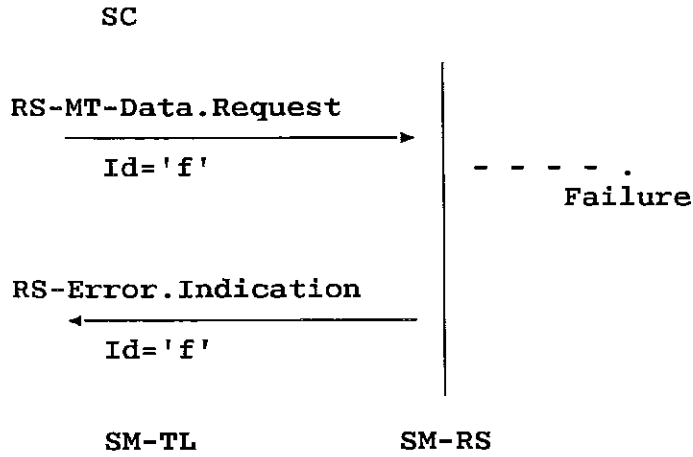

Figure 03.40/12b. Error Service (Mobile terminated short message transfer attempt)

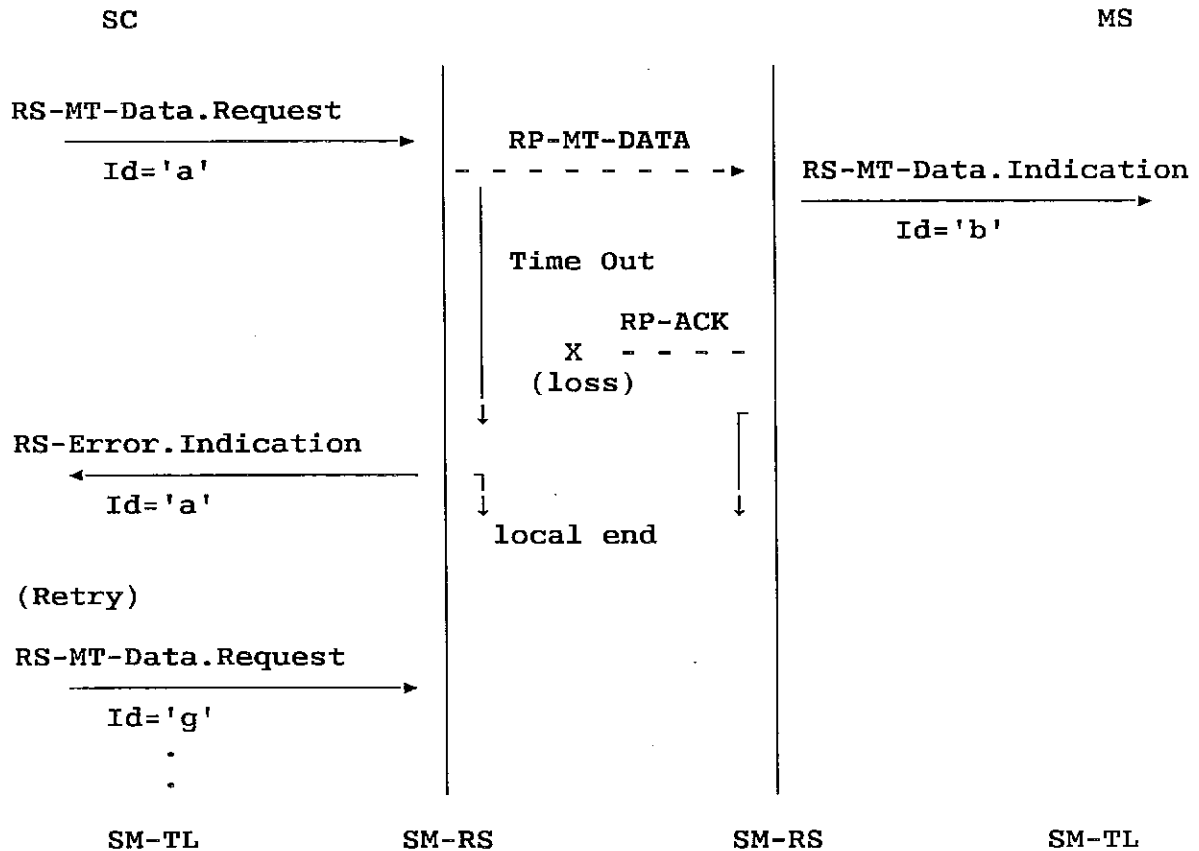

Figure 03.40/13. Example of an abnormal situation: A report does not reach the SC.

Note: The time out indicated in Figure 03.40/13 should be set at SM-RL.

9.3.3. Definition of the primitives

This section defines the primitives and the parameters of the primitives.

9.3.3.1. RS-MT-Data

Parameter	RS-MT-Data 1)	
	Request	Indication
RS-Short-Message-Identifier	M	M
RS-Destination-Address	M	-
RS-Originating-Address	M	M
RS-Priority	O	-
RS-User-Data	M	M

Note 1 : Provision: Mandatory (M), Optional (O) or Not present (-)

RS-MT-Data.Request is used by the SM-TL of the SC to send a message. The primitive contains an indication of the address of the recipient. The parameter RS-Short-Message-Identifier has to be stored by the SM-RL in order to be able to link this request to the report expected by SM-TL.

Because the SM-TL waits for a report, the resources involved in the message transfer shall not be released.

RS-MT-Data.Indication is issued by the SM-RL of the MS. SM-RL has to provide the Short-Message-Identifier parameter.

9.3.3.2. RS-MO-Data

Parameter	RS-MO-Data 1)	
	Request	Indication
RS-Short-Message-Identifier	M	M
RS-Destination-Address	O 2)	-
RS-Originating-Address	-	M
RS-User-Data	M	M

Note 1 : Provision: Mandatory (M), Optional (O) or Not present (-)

Note 2 : If not present, the SC address shall be found within the SM-RL entity of the MS.

RS-MO-Data.Request is used by the SM-TL of the MS to send a message. The parameter RS-Short-Message-Identifier has to be stored by the SM-RL in order to be able to link this request to the report expected by SM-TL.

Because the SM-TL waits for the report, the resources involved in the message transfer shall not be released.

RS-MO-Data.Indication is issued by the SM-RL of the SC. SM-RL has to provide the Short-Message-Identifier parameter.

9.2.3.3. RS-Report

Parameter	RS-Report 1) Indication
RS-Short-Message-Identifier	M

Note 1 : Provision: Mandatory (M)

RS-Report.Indication is issued by the SM-RL when receiving an RP-ACK. When sending this primitive, SM-RL releases the resources involved by the short message transfer (e.g. memory resources).

9.3.3.4. RS-Error

Parameter	RS-Error 1) Indication
RS-Short-Message-Identifier	0 2)
RS-Messages-Waiting-Set	0 3)
RS-Cause	M

Note 1 : Provision: Mandatory (M) or Optional (O)

Note 2 : In the RS-Error.Indication the parameter Short-Message-Identifier is not present when the SM-TL is unable to link an occurrence of a problem on the MS-SC link with a message previously sent.

Note 3 : Relevant only in the direction SMS-GMSC -> SC.

RS-Error.Indication is issued by the SM-RL. When the primitive is issued, the SM-RL informs the SM-TL that a problem (identified by the 'RS-Cause' parameter) has occurred in the transmission of a previously issued RS-Data.Request. If SM-RL is unable to find the link, the parameter RL-Short-Message-Identifier is not present. The RS-Error.Indication terminates the message transfer, and the resources are released.

9.3.3.5. RS-Alert

Parameter	RS-Alert 1) Indication
RS-Alerting-MS	M

Note 1 : Provision: Mandatory (M)

RS-Alert.Indication is issued by the SM-RL at the SC on receipt of an RP-ALERT from the SMS-GMSC (see section 9.3.5). The primitive is used to inform the SM-TL that an MS which was previously unattainable has recovered operation.

9.3.4. Definition of parameters

9.3.4.1. RS-Short-Message-Identifier

The RS-Short-Message-Identifier parameter links an RS-Report or an RS-Error to an RS-MT-Data or an RS-MO-Data. A RS-Short-Message-Identifier cannot be re-used during a certain period (the frozen period) in order to ensure that all the reports (normal or not) have arrived.

9.3.4.2. RS-Destination-Address

The RS-Destination-Address parameter defines the address of the destination entity (either SC or MS).

9.3.4.3. RS-Originating-Address

The RS-Originating-Address parameter defines the address of the originating entity (either SC or MS). This parameter is always mandatory even if the originating entity is the default SC.

9.3.4.4. RS-Priority

The RS-Priority parameter is used by the SM-TL entity within the SC to indicate to the network whether or not a message transfer attempt shall be carried out in the case that the MWD list in HLR is not empty, see section 3.2.5.

9.3.4.5. RS-Cause

The RS-Cause parameter is transferred from the SM-RL to the SM-TL when a problem occurs on the link between the SC and the MS, indicating the reason.

9.3.4.6. RS-Alerting-MS

The RS-Alerting-MS parameter defines the MS which is recognized to have recovered operation.

9.3.4.7. RS-Messages-Waiting-Set

The RS-Messages-Waiting-Set parameter is used to indicate to the SM-TL entity within the SC that the MS is not attainable and that the SC address has been included in the MWD list in the HLR, see section 3.2.6.

9.3.4.8. RS-User-Data

The RS-User-Data parameter deals with the data included in the TS primitives. These data are an element of protocol of the SM-TL. The RS-User-Data parameter denotes both the data and the length of these data.

9.3.5. Protocol element repertoire at SM-RL

Different protocols are required between different pairs of SM-RL entities. Those are described in other GSM recommendations. This section gives a survey of the different information elements which have to be conveyed between those entities. (Note that the notation of the protocol and information elements may vary between different GSM recommendations).

The SM-RL comprises the following 5 protocol elements:

RP-MO-DATA	for transferring a TPDU from MS to SC
RP-MT-DATA	for transferring a TPDU from SC to MS
RP-ACK	for acknowledging an RP-MO-DATA or an RP-MT-DATA
RP-ERROR	for informing of an unsuccessful RP-MO-DATA or an RP-MT-DATA transfer attempt
RP-ALERT-SC	for alerting the SC that the MS has recovered operation (information sent from the HLR to the SC)

9.3.5.1. RP-MO-DATA

Basic elements of the RP-MO-DATA type.

Abbr.	Reference	P1)	Description
RP-OA	RP-Originating-Address	++-	Address of the originating MS.
RP-DA	RP-Destination-Address	-++	Address of the destination SC.
RP-UD	RP-User-Data	+++	Parameter containing the TPDU

1) : Provision on the links SC<->MSC, MSC<->MSC and MSC<->MS indicated by 'xxx', where x may be either '+' or '-', dependent on whether the parameter is mandatory or not on the respective link.

9.3.5.2. RP-MT-DATA

Basic elements of the RP-MT-DATA type.

Abbr.	Reference	p1)	Description
RP-PRI	RP-Priority-Request	+--	Parameter indicating whether or not the short message transfer should be stopped if the originator SC address is already contained in the MWD.
RP-OA	RP-Originating-Address	+++	Address of the originating SC.
RP-DA	RP-Destination-Address	++-	Address of the destination MS.
RP-UD	RP-User-Data	+++	Parameter containing the TPDU

1) : Provision on the links SC<->MSC, MSC<->MSC and MSC<->MS indicated by 'xxx', where x may be either '+' or '-', dependent on whether the parameter is mandatory or not on the respective link.

9.3.5.3. RP-ACK

The RP-ACK does not contain any specific information elements.

9.3.5.4. RP-ERROR

Basic elements of the RP-ERROR type.

Abbr.	Reference	p1)	Description
RP-MSI	RP-MW-Set-Indication	+--	Parameter indicating whether or not the MWI has been updated. 2)
RP-CS	RP-Cause	---	Parameter identifying the error type. The RP-Cause parameter gives the reason why a short message transfer attempt fails. When included in an RP-ERROR being sent in the direction to the SC, RP-cause may take the values as indicated in Table 03.40/1. When included in an RP-ERROR being sent in the direction to the MS, RP-Cause may take the values as indicated in Rec. GSM 04.11.

1) : Provision on the links SC<->MSC, MSC<->MSC and MSC<->MS indicated by 'xxx', where x may be either '+' or '-',

dependent on whether the parameter is mandatory or not on the respective link.

- 2) : Only present when the RP-ERROR is transferred from the SMS-IW MSC to the SC.

9.3.5.5. RP-ALERT-SC

Basic elements of the RP-ALERT-SC type:

Abbr.	Reference	p1)	Description
RP-MSIsdn	RP-International-MS- ISDN-Number	M	MSIsdn of the MS.

- 1) : Provision; Mandatory (M).

10. Fundamental procedures within the point-to-point SMS

The point-to-point SMS comprises 3 fundamental procedures:

- 1) Short message mobile terminated. This procedure consists of all necessary operations to
 - a) transfer a short message from the SC to the MS
 - b) return a report to the SC, containing the result of the message transfer attempt.
- 2) Short message mobile originated. This procedure consists of all necessary operations to
 - a) transfer a short message from the MS to the SC
 - b) return a report to the MS, containing the result of the message transfer attempt.
- 3) Transfer of an Alert. This procedure consists of all necessary operations for an HLR or a VLR to initiate a transfer of an Alert to a specific SC, informing the SC that the MS has recovered operation.

Rec. GSM 09.02 defines operations necessary for the provision of the Short Message Service point-to-point. The operations defined in section 10 describe the requirement that the Short Message Service puts upon the network functionality. If discrepancies exist in nomenclature, it is the Rec. GSM 09.02 that will be the reference.

Annex 3 indicates the flow of primitives and parameters during the short message transfer between the SC and the MS. Both the Mobile terminated and the Mobile originated cases are covered.

10.1. Short message mobile terminated

The entities involved in this procedure are depicted in Figure 03.40/14.

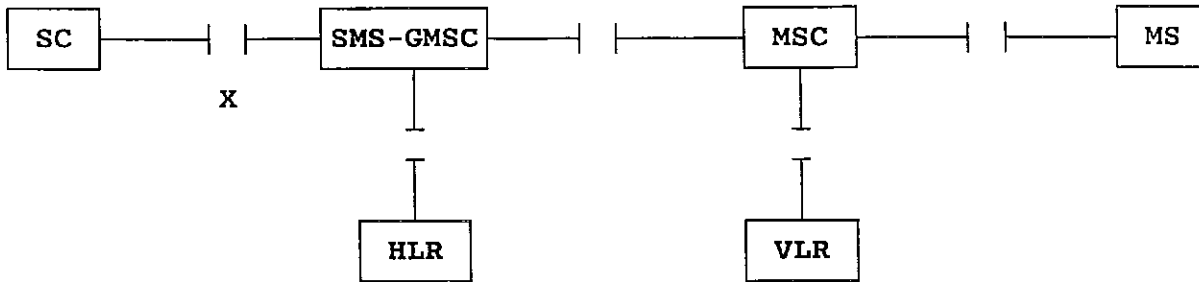
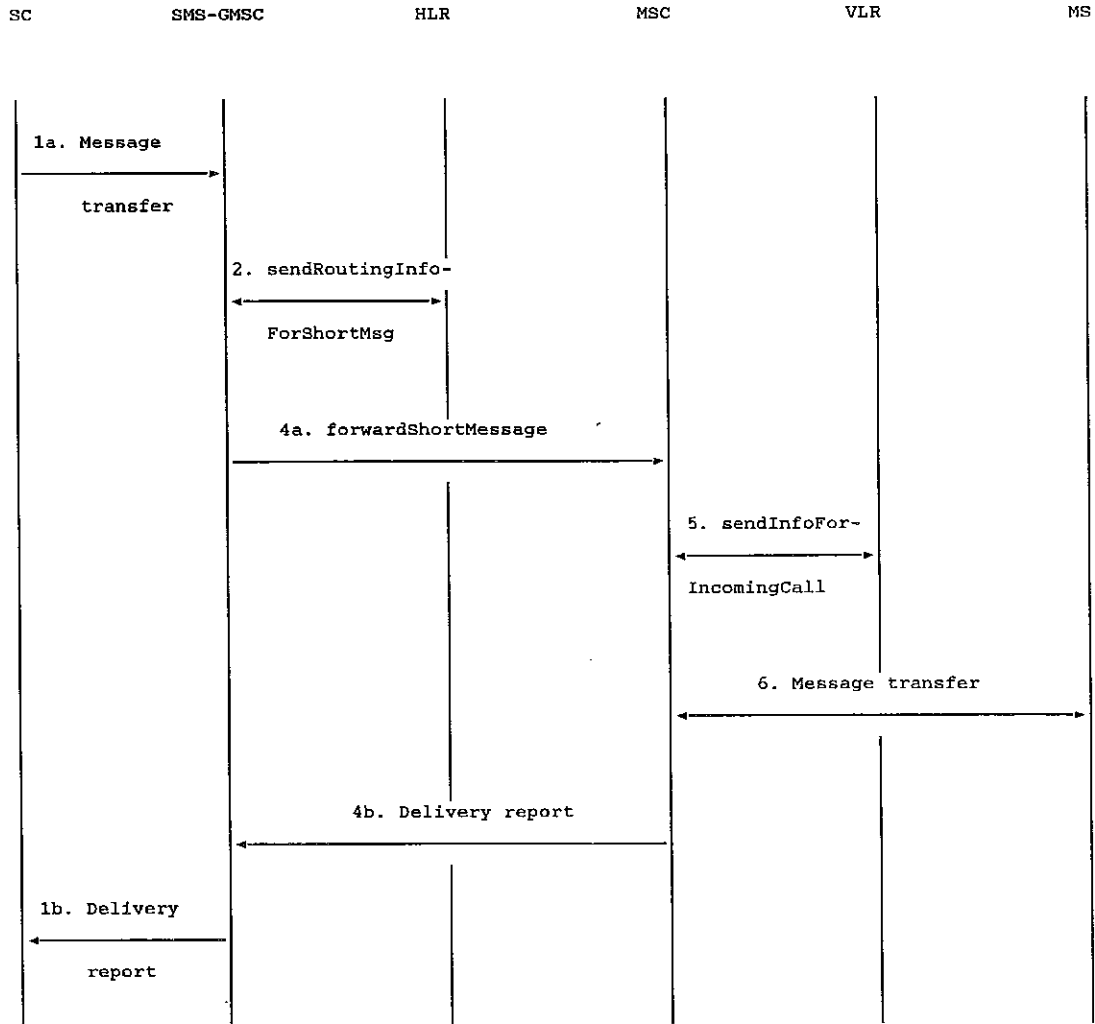

Figure 03.40/14. Interfaces involved in the Short message mobile terminated procedure. GSM 03.02. X is the interface between an MSC and an SC as defined in section 5.

In Figure 03.40/15, sequence diagrams are shown for the following basic situations of short message mobile terminated transfer attempt:

- Successful short message transfer
- Short message transfer attempt failing due to error at the SMS-GMSC
- Short message transfer attempt failing due to negative outcome of HLR information retrieval
- Short message transfer attempt failing due to error at the MSC
- Short message transfer attempt failing due to negative outcome of VLR information retrieval
- Short message transfer attempt failing due to erroneous message transfer on the radio path.

References to the relevant specifications of the different operations are given in section 4.



- : Operation invocation or message transfer
- ←→ : Successful operation invocation or message transfer including report

Figure 03.40/15 a). Successful short message transfer attempt.

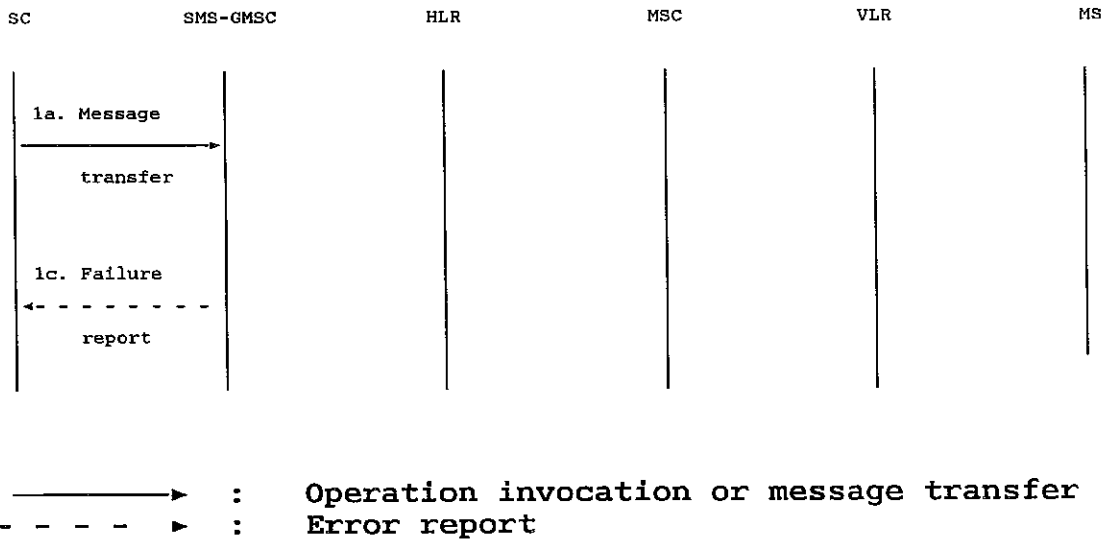

Figure 03.40/15 b). Short message transfer attempt failing due to error at the SMS-GMSC.

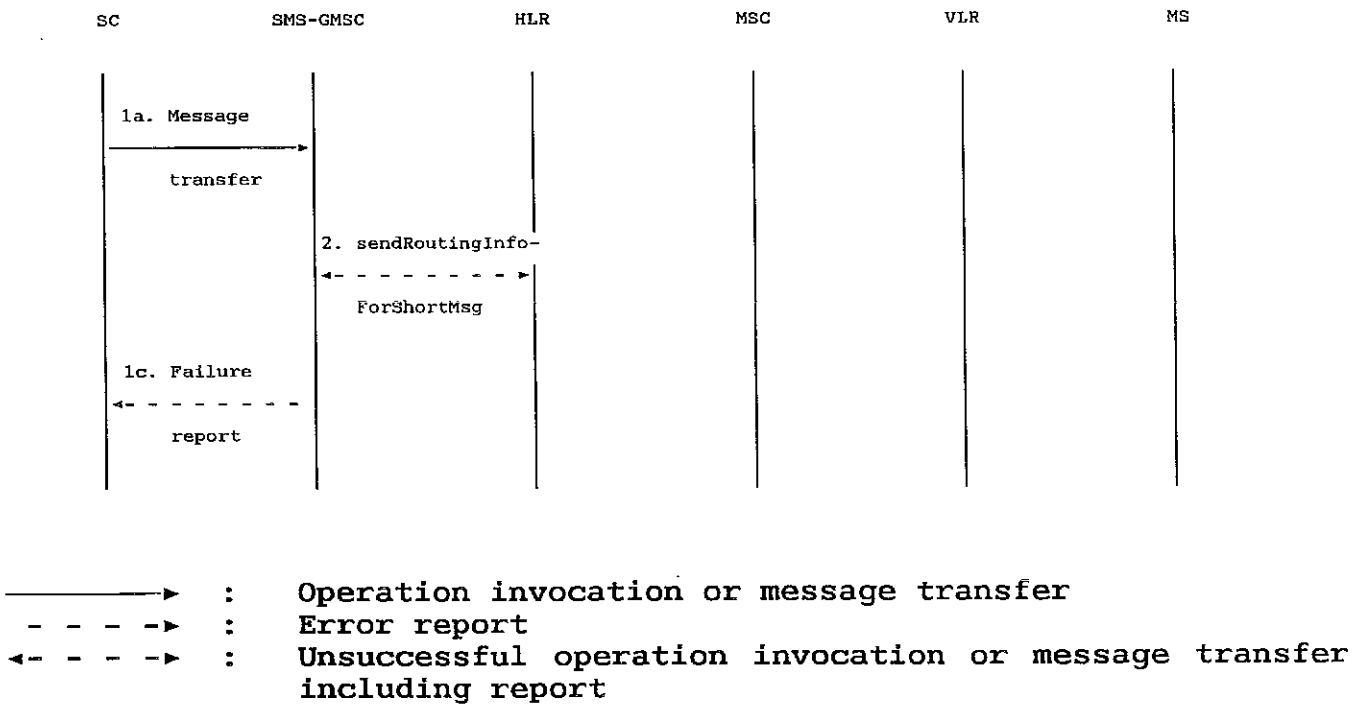
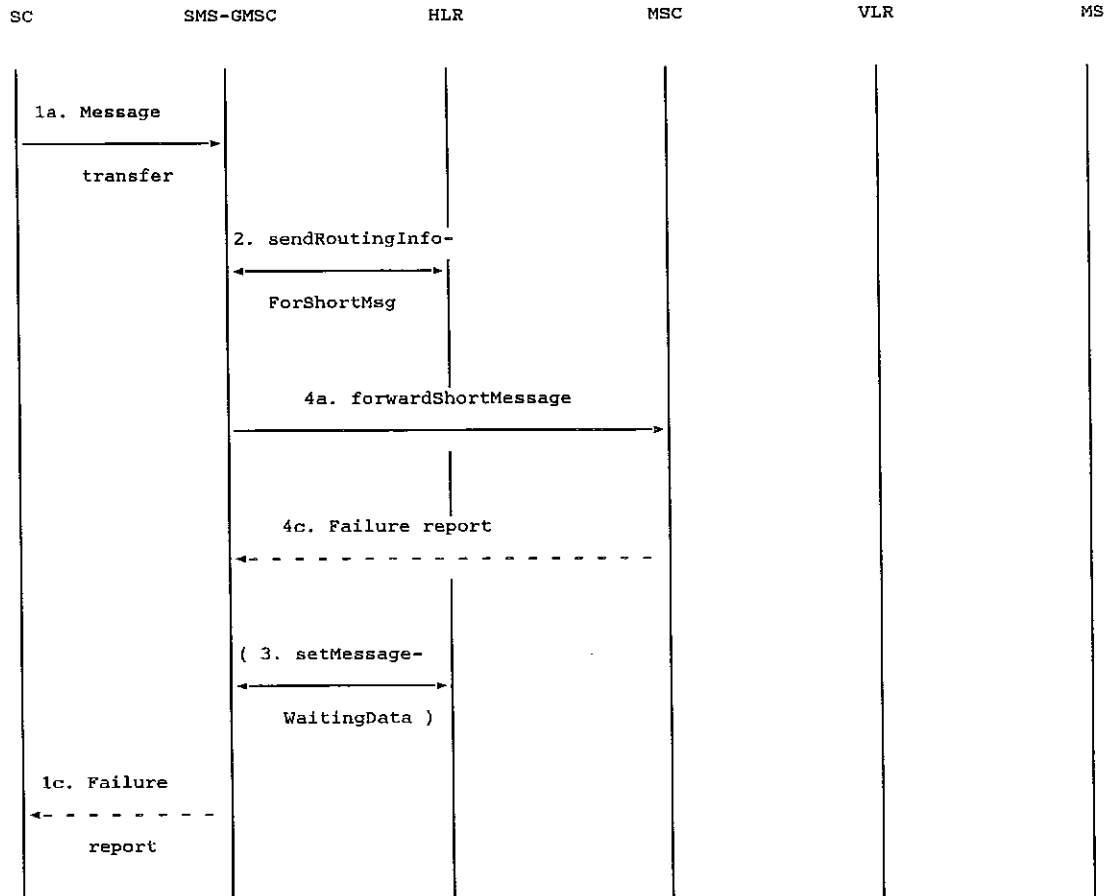
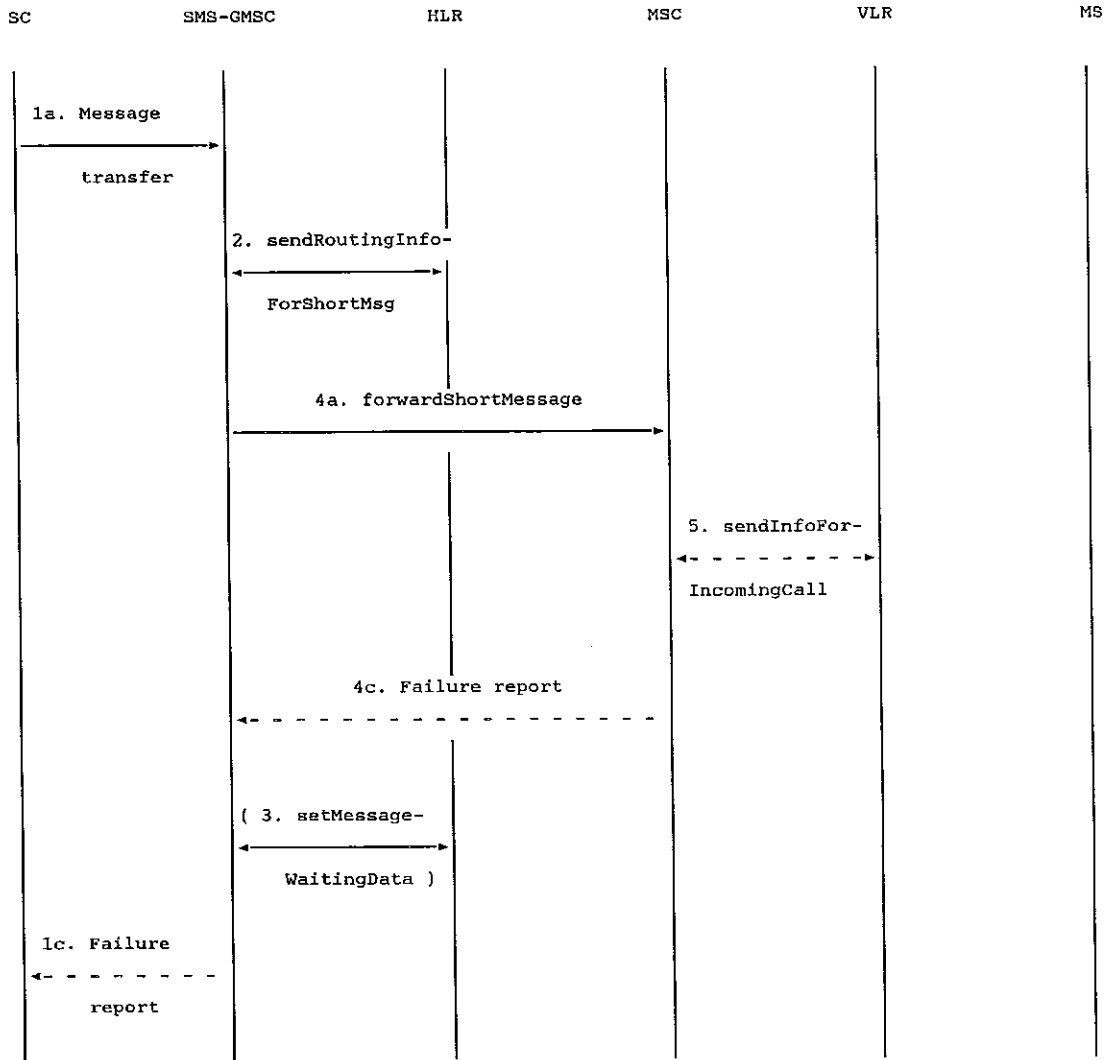

Figure 03.40/15 c). Short message transfer attempt failing due to negative outcome of HLR information retrieval.



- > : Operation invocation or message transfer
- ←———— : Successful operation invocation or message transfer including report
- - - -> : Error report
- ←- - - -> : Unsuccessful operation invocation or message transfer including error report (or with missing confirmation)

Figure 03.40/15 d). Short message transfer attempt failing due to error at the MSC.



- > : Operation invocation or message transfer
- ←———— : Successful operation invocation or message transfer including report
- - - -> : Error report
- ←- - - -> : Unsuccessful operation invocation or message transfer incl. error report (or with missing confirmation)

Figure 03.40/15 e). Short message transfer attempt failing due to negative outcome of VLR information retrieval.

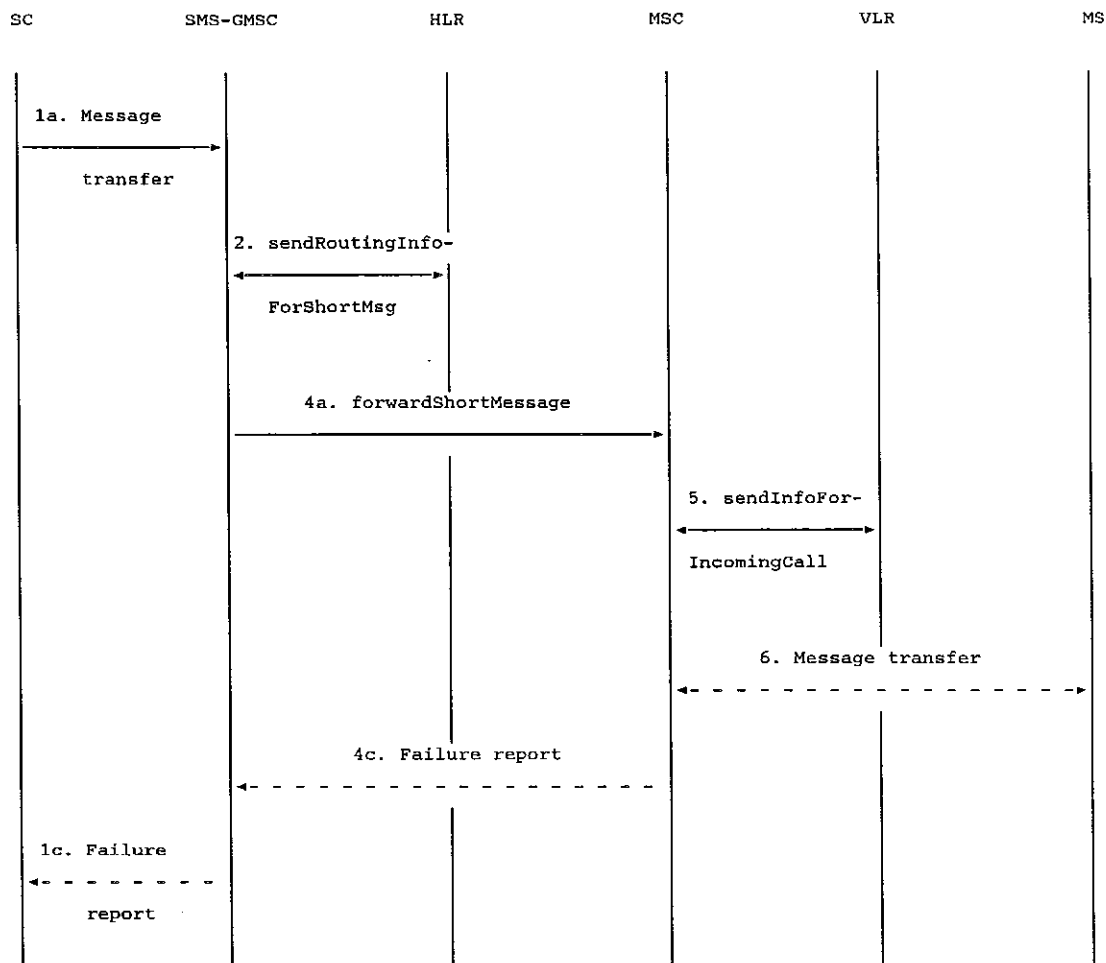

- > : Operation invocation or message transfer
- ←————> : Successful operation invocation or message transfer including report
- - - -> : Error report
- ←- - - -> : Unsuccessful operation invocation or message transfer incl. error report (or with missing confirmation)

Figure 03.40/15 f). Short message transfer attempt failing due to erroneous message transfer on the radio path.

Operation 1: Message transfer SC -> SMS-GMSC

This operation is used to transfer a short message from an SC to an SMS-GMSC.

The operation consists of

- the transfer of a message containing the RS-User-Data and other parameters as defined in section 9.3.3.1 from the SC to the SMS-GMSC (see '1a. Message transfer' in Figure 03.40/15); and

- the return of either an 'Failure report' (see 1c. in Figure 03.40/15) or a 'Delivery report' (see 1b. in Figure 03.40/15).

'Failure report' is returned to the SC when the SMS-GMSC has received indication from another entity (MSC or HLR) the procedure was unsuccessful. The error indications which the SMS-GMSC may receive from the MSC, HLR, VLR or MS enable the SMS-GMSC to return one of the error indications given in section 3.3 back to the SC.

Operation 2: sendRoutingInfoForShortMsg

The operation is an interrogation of the HLR by the SMS-GMSC to retrieve information necessary to forward the short message.

Operation 3: setMessageWaitingData

The operation provides a means for the SMS-GMSC to request the HLR to add an SC address to the MWD, and is activated when the SMS-GMSC receives an absent subscriber indication from the MSC.

Operation 4: forwardShortMessage

The operation provides a means for the SMS-GMSC to transfer a short message to the MSC at which the MS is currently located.

The operation works in tandem with the forwarding of the short message from the MSC to the MS. Thus, the outcome of the operation comprises either success, i.e. that the message has been delivered to the MS; or a failure that may be caused by several reasons, e.g. failure in the transfer SMS-GMSC -> MSC, MS being detached, or no paging response.

Operation 5: sendInfoForIncomingCall

The operation provides a means for the MSC to retrieve subscriber information from VLR for mobile terminated short message transfer. The operation may be associated with an authentication procedure, as shown in Figure 03.40/16, and is the same as is used for incoming call set-up. Unsuccessful retrieval (e.g. absent subscriber) is indicated by a cause indication to the SMS-GMSC.

Note that the MSC will experience invocation of 'completeCall' by the VLR as the positive response upon 'sendInfoForIncomingCall'.

An overall depiction of how operation 5 interacts with signalling on the radio path is given in Figure 03.40/16.

It should be noted that the MWF setting is implicitly carried out when the message transfer is denied due to IMSI DETACH.

Operation 6: Message transfer MSC -> MS

The operation is used to transfer a short message from the MSC to the MS.

If the transfer is not successful, e.g. due to the MS losing radio coverage after having successfully authenticated, a failure report (RP-ERROR) is returned to the SMS-GMSC. In this case, neither MWD nor MWF will be updated.

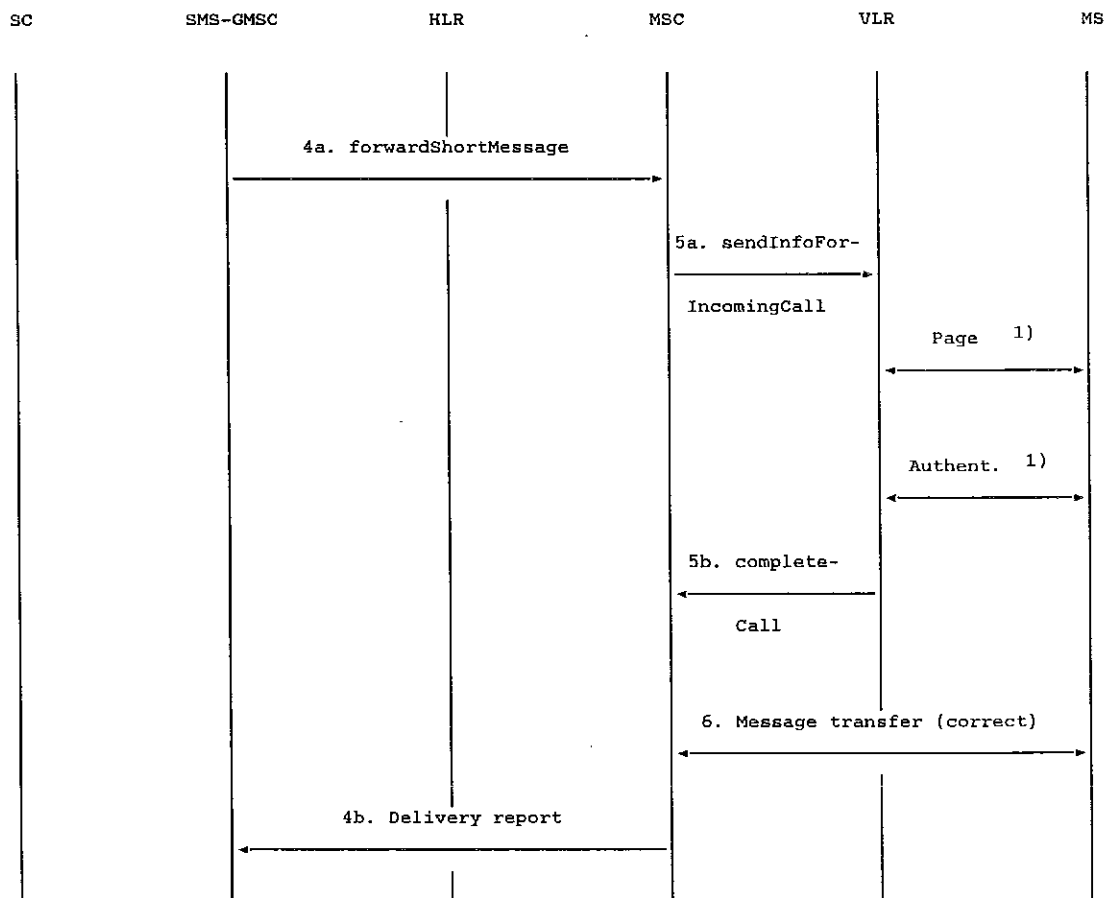

- : Operation invocation or message transfer
- ← : Successful operation invocation or message transfer incl. report

References:

- 1) : Described in Rec GSM 04.08 and Rec GSM 09.02

Figure 03.40/16 a). 'Send information for I/C call set-up' procedure; error free case.

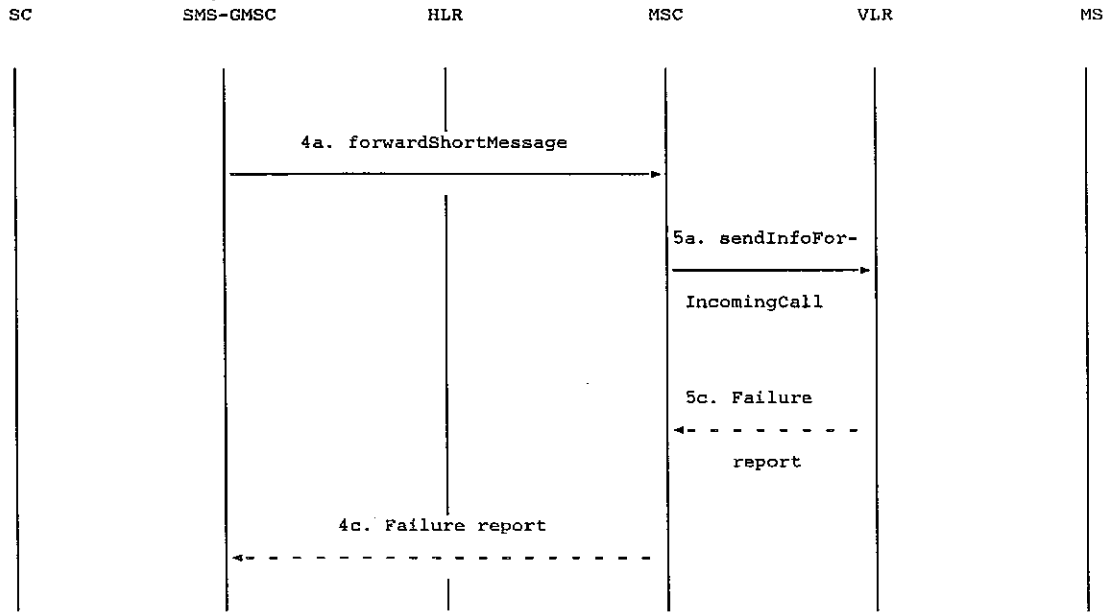

————> : Operation invocation or message transfer
 - - - -> : Error report

Figure 03.40/16 b). 'Send information for I/C call set-up' procedure; erroneous case: absent subscriber (e.g. IMSI DETACH).

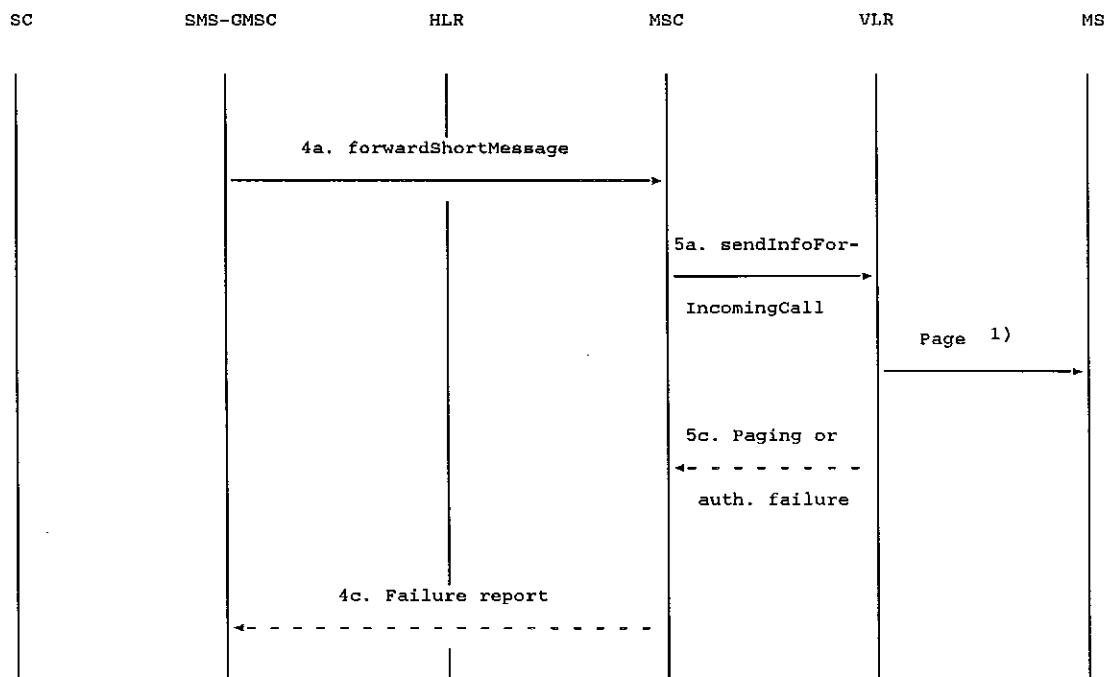

————▶ : Operation invocation or message transfer
 - - - -▶ : Error report

References:

- 1) : Described in Rec GSM 04.08 and Rec GSM 09.02

Figure 03.40/16 c). 'Send information for I/C call set-up' procedure; erroneous case: Absent subscriber (e.g. no paging response).

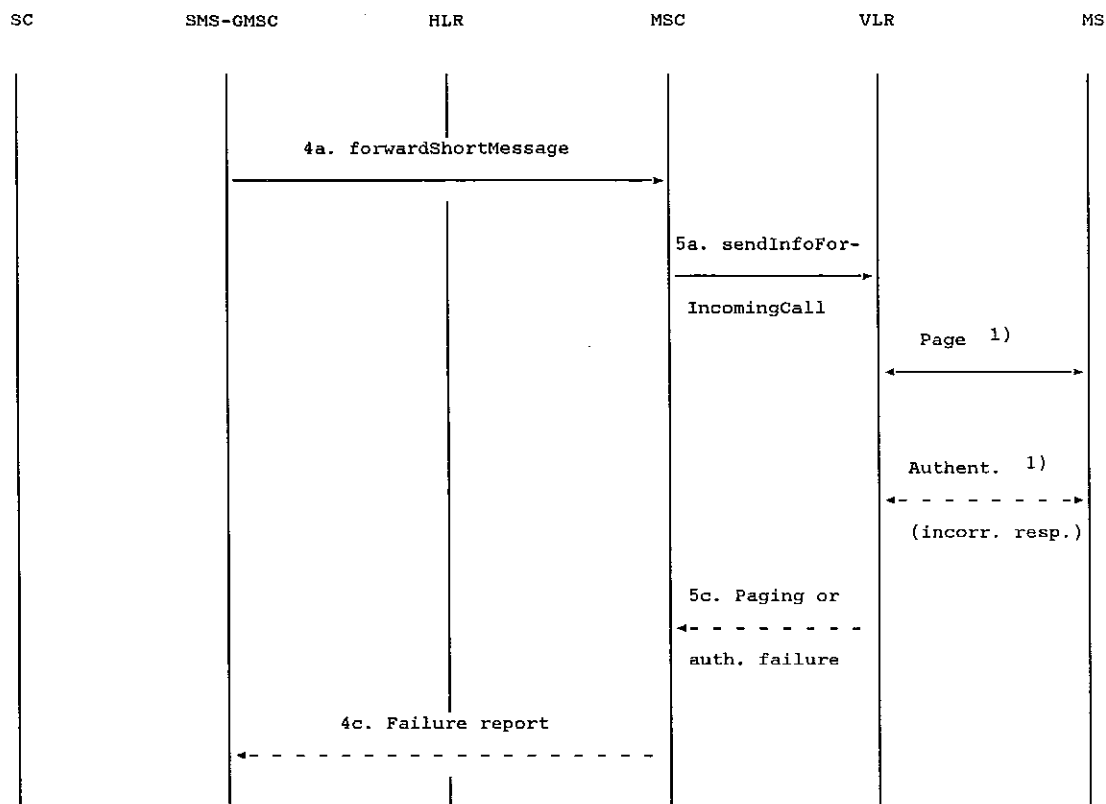

- > : Operation invocation or message transfer
- - - -> : Error report
- <- - - -> : Unsuccessful operation invocation or message transfer including error report (or with missing confirmation)

References:

- 1) : Described in Rec GSM 04.08 and Rec GSM 09.02

Figure 03.40/16 d). 'Send information for I/C call set-up' procedure; incorrect authentication.

10.2. Short message mobile originated

The entities involved in this procedure is depicted in Figure 03.40/17.

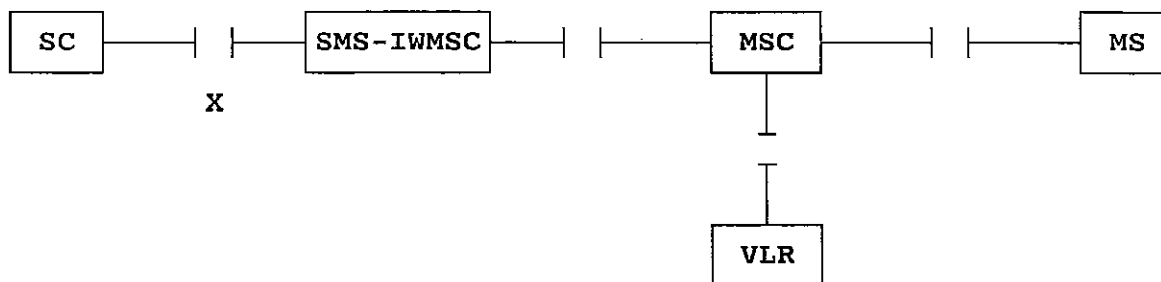
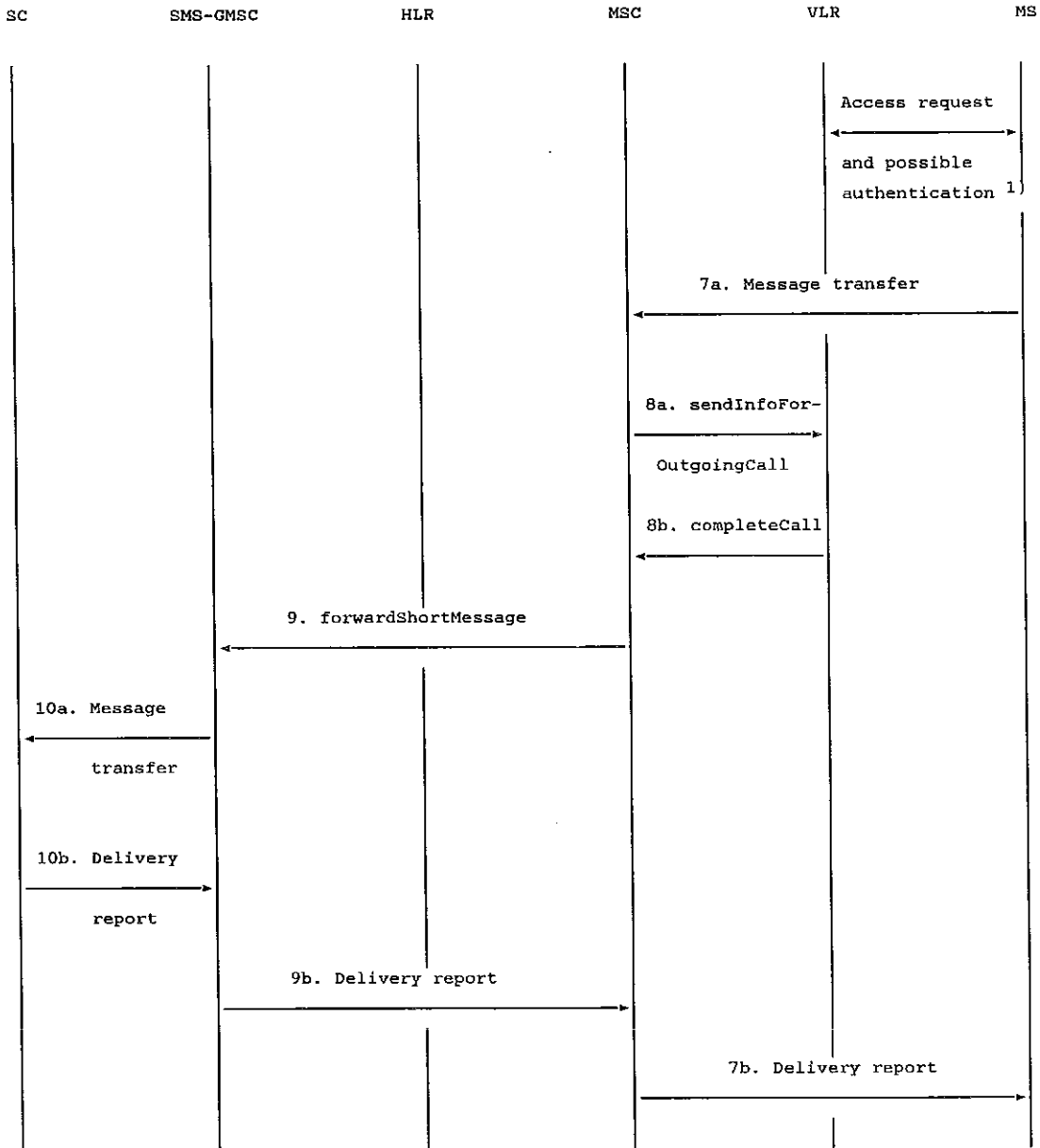

Figure 03.40/17. Interfaces involved in the Short message mobile originated procedure. GSM 03.02. X is the interface between an MSC and an SC as defined in chapter 5.

In Figure 03.40/18, sequence diagrams for the following basic situations of short message mobile terminated transfer attempt:

- Successful short message transfer
- Short message transfer attempt failing due to error at the MSC
- Short message transfer attempt failing due to negative outcome of VLR information retrieval
- Short message transfer attempt failing due to error at the SMS-IW MSC
- Short message transfer attempt failing due to error at the SC.

References to the relevant specifications of the different operations are given in section 4.



→ : Operation invocation or message transfer
 ← : Successful operation invocation or message transfer including report

References:

1) : Described in Rec GSM 04.08 and Rec GSM 09.02

Figure 03.40/18 a). Successful short message transfer attempt.

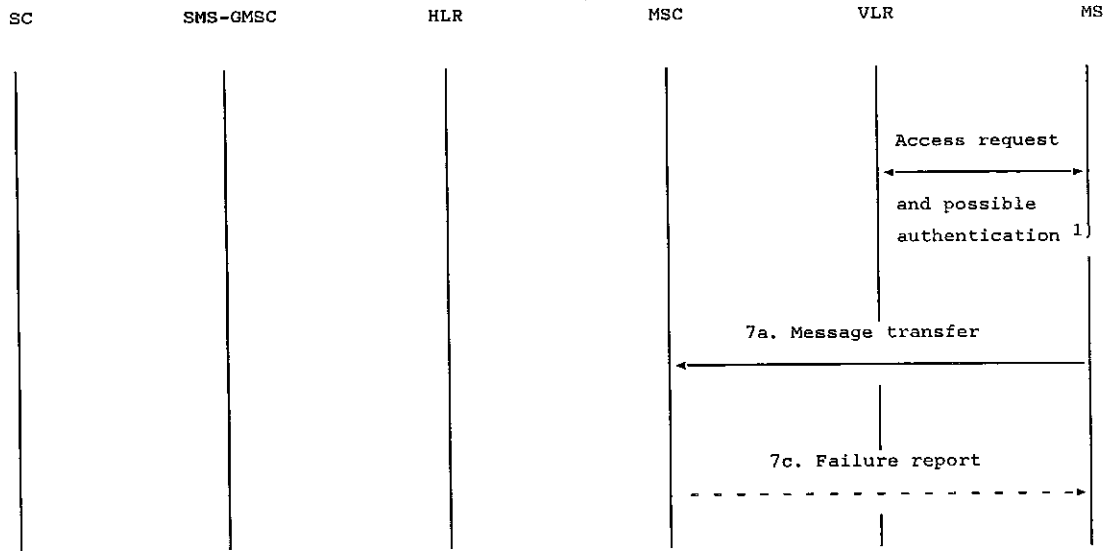

- : Operation invocation or message transfer
- ←→ : Successful operation invocation or message transfer including report
- - - -> : Error report

References:

- 1) : Described in Rec GSM 04.08 and Rec GSM 09.02

Figure 03.40/18 b). Short message transfer attempt failing due to error at the MSC.

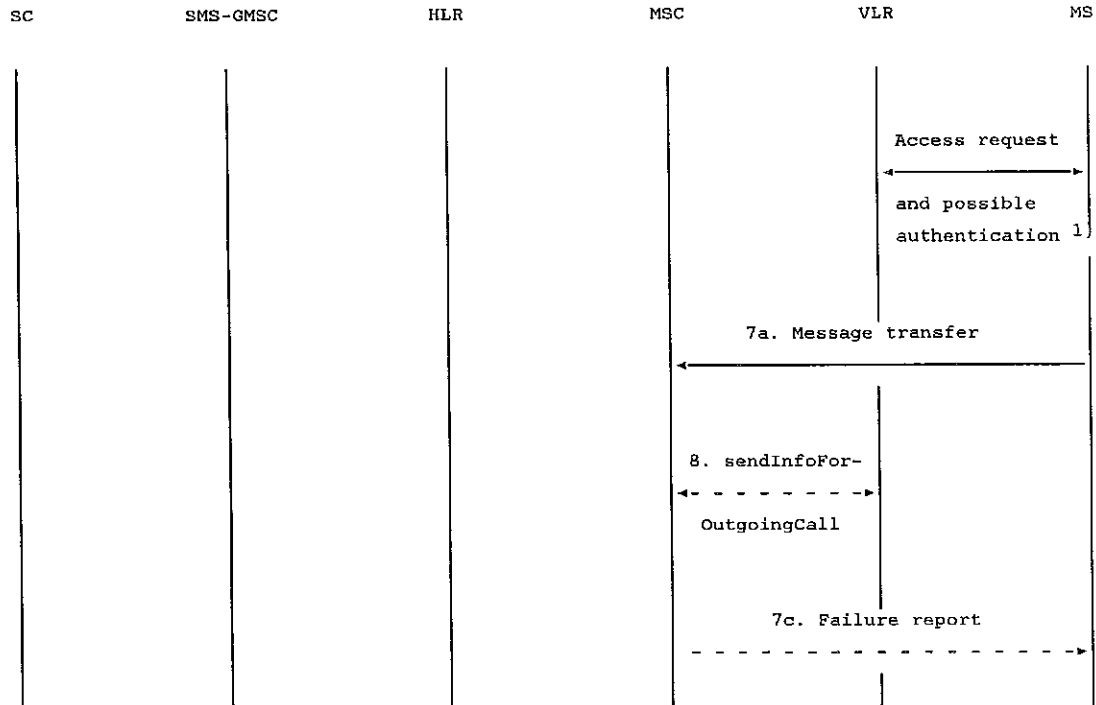

- > : Operation invocation or message transfer
- ←———— : Successful operation invocation or message transfer including report
- - - -> : Error report
- ←- - - -> : Unsuccessful operation invocation or message transfer incl. error report (or with missing confirmation)

References:

1) : Described in Rec GSM 04.08 and Rec GSM 09.02

Figure 03.40/18 c). Short message transfer attempt failing due to negative outcome of VLR information retrieval.

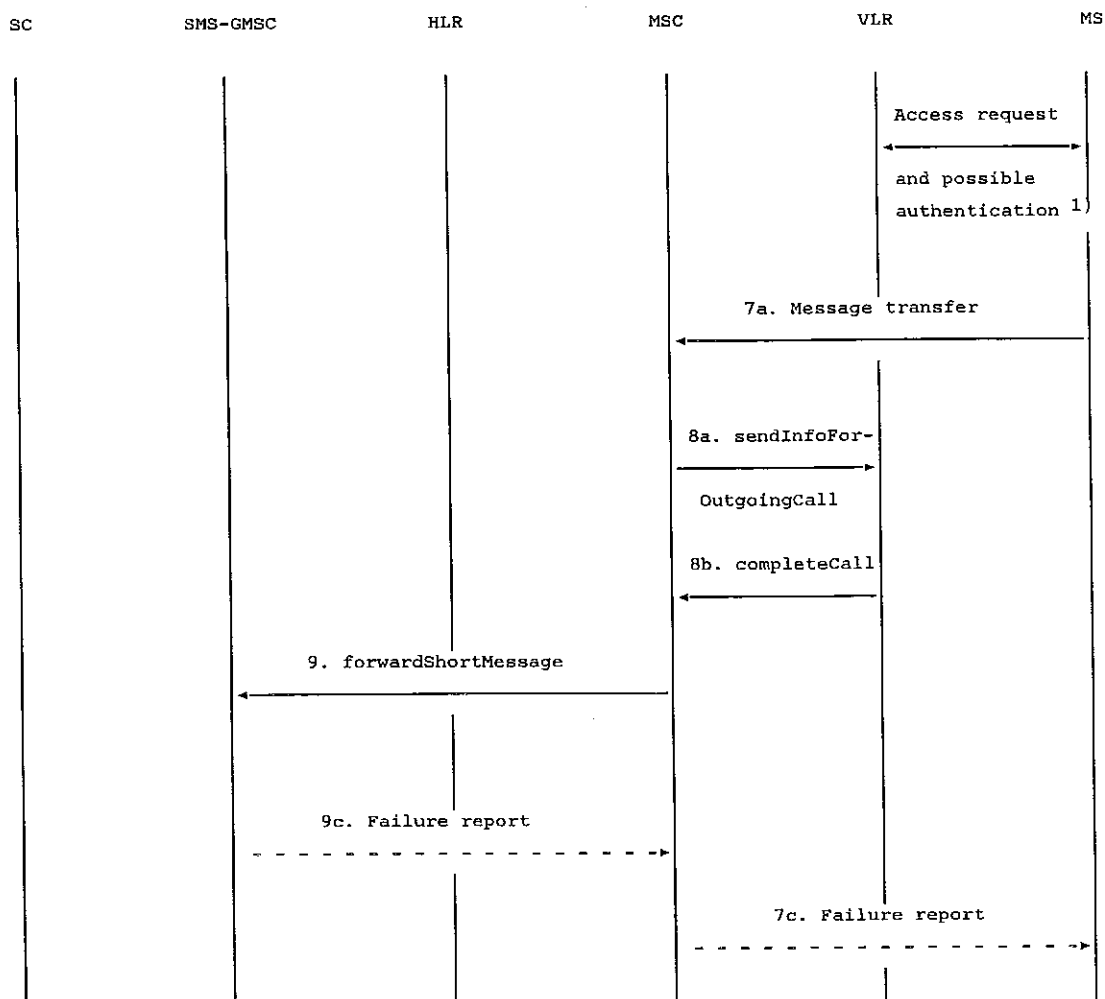

- > : Operation invocation or message transfer
- ←————> : Successful operation invocation or message transfer including report
- - - -> : Error report

References:

1) : Described in Rec GSM 04.08 and Rec GSM 09.02

Figure 03.40/18 d). Short message transfer attempt failing due to error at the SMS-IWMSC.

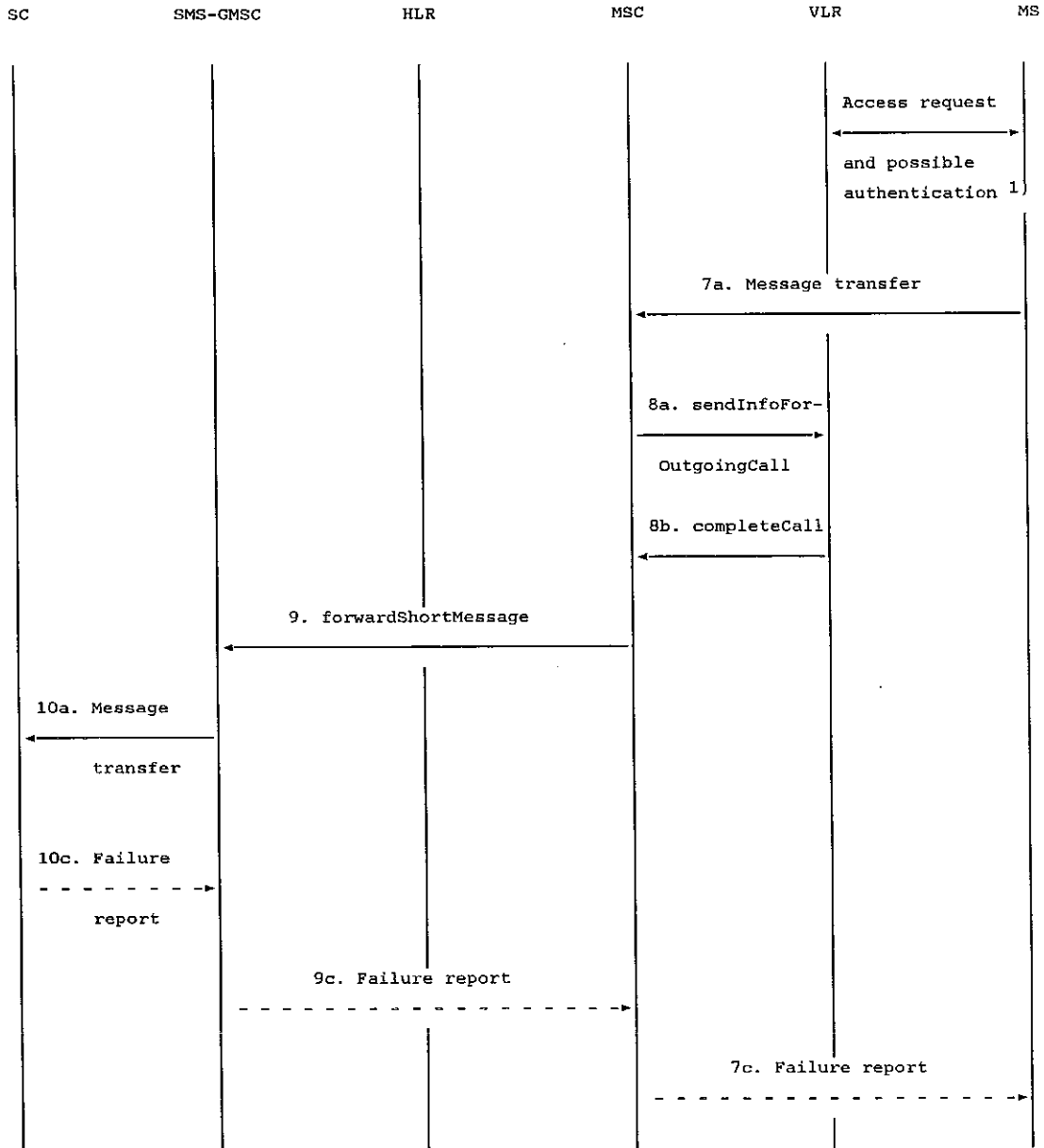

- > : Operation invocation or message transfer
- < : Successful operation invocation or message transfer including report
- - - -> : Error report

References:

1) : Described in Rec GSM 04.08 and Rec GSM 09.02.

Figure 03.40/18 e). Short message transfer attempt failing due to error at the SC.

Operation 7: Message transfer MS -> MSC

The operation is used to transfer a short message from the MS to the MSC.

Operation 8: sendInfoForOutgoingCall

The operation provides a means for the MSC to verify from VLR that the mobile originated short message transfer does not violate supplementary services invoked, e.g. CUG or barring.

Note that the MSC will experience invocation of 'completeCall' by the VLR as the positive response upon 'sendInfoForOutgoingCall'. 'completeCall' carries the MsIsdn of the originating MS being transferred to the SC at SM-RL.

Operation 9: forwardShortMessage

The operation provides a means for the MSC to transfer a short message to the SMS-IWMSC.

The procedure is required if the serving MSC cannot access the SC directly, e.g. because it has no connection to SC (see section 5).

The procedure works in tandem with the forwarding of the short message from the SMS-IWMSC to the SC. Thus, the outcome of the operation comprises either success, i.e. that the message has been delivered to the SC; or a failure that may be caused by several reasons, e.g. failure in the transfer MSC --> SMS-IWMSC, SC does not comply.

Operation 10: Message transfer SMS-IWMSC -> SC

The operation is used to transfer a short message from an SMS-IWMSC to an SC, and consists of

- the transfer of a message containing the RS-User-Data and other parameters as defined in section 9.3.3.1 from the SMS-IWMSC to the SC (see '8a. Message transfer' in Figure 03.40/18); and
- the return of either an 'Failure report' (see 8c. in Figure 03.40/18) or a 'Delivery report' (see 8b. in Figure 03.40/18).

'Failure report' is returned to the MS when the SMS-IWMSC has received indication from the network or the SC that the procedure was unsuccessful.

10.3. Alert transfer

The entities involved in this procedure are depicted in Figure 03.40/19.

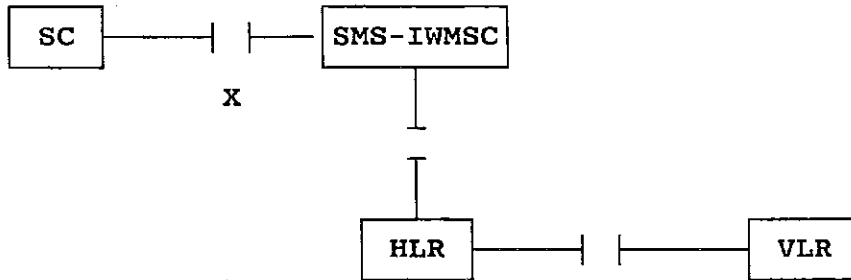
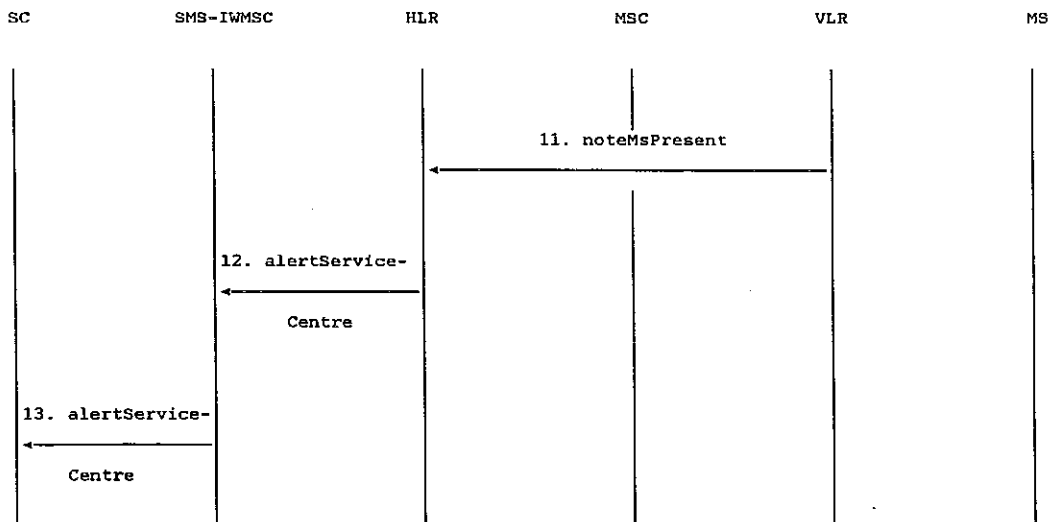

Figure 03.40/19. Interfaces involved in the Alert procedure. X is the interface between an SC and an MSC as defined in section 5.

This procedure consists of the operations shown in Figure 03.40/20.

The operation between HLR and VLR are specified in Rec. GSM 09.02. References to specifications of other operations are given in section 4.



→ : Operation invocation or message transfer

Figure 03.40/20. The alert procedure.

Operation 11: noteMsPresent

The operation provides a means to transfer alert information from VLR to HLR.

The procedure is activated when the VLR detects that the MS is active, i.e. when the MS responds to a paging request.

Operation 12: alertServiceCentre

The operation provides a means to transfer alert information from HLR to MSC.

Operation 13: alertServiceCentre

The operation provides a means to transfer alert information from an SMS-IW MSC to an SC.

The operation consists of transfer of a message ('RP-ALERT-SC') containing the parameters as defined in section 9.3.3.4 from the SMS-IW MSC to the SC.

ANNEX 1

A PROTOCOL STACK FOR INTERCONNECTING SCs AND MSCs

(This annex is not an integral part of this recommendation.)

This annex specifies a stack of data communication protocols for the purpose of relaying short messages and alerts between Short Message Service Centers (SC) and Gateway/Interworking MSCs (MSC) for the Short Message Service (SMS).

The resulting protocol stack is just one example for the implementation of the Short Message Relay Layer (SM-RL). The requirements put upon the Short Message Relay Layer are briefly described in section 9 of the body text.

Thus, this annex gives one elaboration of the SM-RL specification into an implementable stack of protocols. This annex only relates to the protocol interface between SCs and MSCs; other aspects of the SM-RL (such as the mobile station interface and the service primitives) are not elaborated.

1. The transport service

The protocols are based on the connection oriented transport service, as specified in CCITT recommendation X.214.

One way of providing such a transport service is to use a PSPDN with the X.25 interface as specified in ISO standard ISO 8208, and to use the class 0 transport protocol on top of the network connection, as specified in recommendation X.224.

Two ways of using transport connections are specified:

- transient connection, where the transport connection is maintained only for the duration of relay operations,
- and
- semi-permanent connection, where the transport connection is maintained for an unlimited time.

The party that established a transport connection is responsible for clearing it as well, and hence chooses between transient and semi-permanent connection. During SMR-BIND (see sections 5 and 6), the called party may refuse semipermanent connection, however, thereby forcing the connection transient.

2. The session layer protocol

On top of each transport connection, the session layer protocol specified in recommendations X.215 and X.225 is used, with the following functional units: Kernel functional unit, Duplex functional unit.

3. The presentation layer

The presentation layer protocol to be used on top of each session connection is as specified in recommendations X.216 and X.226. Only the Kernel functional unit is used.

The application layer PDUs for the new SMRSE service element (defined in section 5) are specified in section 6 with ASN.1 (specified in recommendation X.208); the ASN.1 basic encoding rules (specified in recommendation X.209) are used to encode those PDUs.

4. Service elements on the application layer

On top of each presentation connection, the following application layer service elements are used:

- Association Control Service Element (ACSE), specified in recommendations X.217 and X.227,
- Remote Operations Service Element (ROSE), specified in recommendations X.219 (1988) and X.229 (1988), and
- Short Message Relay Service Element (SMRSE), a service element specifically developed for this application.

The ROSE (1988 version) is used as follows:

- asynchronously (Operation Classes 2 to 5), and
- with Association Class 3: both the association-initiating and the association-responding application entities can invoke operations (symmetry).

This results into a asynchronous symmetric situation where both (the application entity in) the SC and (the application entity in) the MSC can invoke a SMRSE operation at any time.

The new SMRSE service element is first defined in the following section, and then specified in ASN.1 notation in section 6.

5. SMRSE definition

This service element defines the following services:

- | | |
|-------------|---|
| SMR-BIND | This operation must be invoked by that party which established the application association; only after that may the remaining SMRSE services be used. This operation reports either success or failure (result or error). |
| SMR-MO-DATA | This operation may be invoked by the application entity in the MSC; it is used to relay one SMS transfer layer PDU from the IWMSC to the SC. This operation reports either success or failure. |
| SMR-MT-DATA | This operation may be invoked by the application entity in the SC; it is used to relay one SMS transfer layer PDU from the SC to the GMSC, to be further relayed to the MS addressed. This operation reports either success or failure, after the full relay attempt to the MS. |
| SMR-ALERT | This operation may be invoked by the application entity in the MSC. It is used as the GMSC-to-SC |

indication of the fact that an MS which was previously unattainable has recovered operation. This operation does not report any outcome.

SMR-UNBIND This operation must be invoked by that party which invoked the SMR-BIND operation, as the last SMRSE operation before releasing the application association. This operation reports success only.

Of the services defined above, SMR-MO-DATA and SMR-MT-DATA semantically mean the relay of short messages across the SC-MSC-connection; SMR-ALERT similarly implements the alerting operation. The SMR-BIND service is used to exchange identifications, passwords, etc., and in order to negotiate the usage of the other services. The SMR-UNBIND service prepares for the release of the application association.

6. Detailed specification of the SMRSE services

On the following pages, the new SMRSE service element is specified with the ASN.1 notation, together with the entire SM-RL protocol.

The Abstract Syntax Notation of
the Short Message Relay Service Element

SMRSE

```
-- Note :   The first two arcs of the object identifier are
--          arbitrarily allocated, the name "cept" is adopted from
--          GSM 12.20 but the value 12 is arbitrary, and the last
--          three arcs are allocated in this module.
```

1st module of 3:

SMS-UsefulDefinitions

```
SMS-UsefulDefinitions { iso identified-organization cept(12)
                        gsm(0) sms(5) id-mod(1)
                        usefulDefinitions(0) }
```

DEFINITIONS

IMPLICIT TAGS

```
::=
BEGIN
```

```
EXPORTS id-ot-SC, id-ot-MSC, id-port, id-ac-so, id-ac-st, id-
        SMRSE, id-as-SMRSE;
```

```
-- gsm is defined in OMEG GSM 12.20 (version 0.0.5). The definition
-- starts from "cept" which has not been defined in that module.
-- For the allocation of the first three arcs of the object
-- identifier see above. These two documents should be reviewed
-- together for consistency.
```

IMPORTS

```
gsm      FROM GSM-useful-definitions
        { iso identified-organization cept(12) gsm(0)
          management(0) notation(6) gsm-useful-
          definitions(0) } ;
```

```
ID ::= OBJECT IDENTIFIER
```

```

-- root for all sms allocations

sms                ID ::= { gsm sms(5) }

-- categories

id-mod             ID ::= { sms 1 } -- modules
id-ot              ID ::= { sms 2 } -- object type
id-pt              ID ::= { sms 3 } -- port types
id-ac              ID ::= { sms 4 } -- appl. contexts
id-ase             ID ::= { sms 5 } -- ASEs
id-as              ID ::= { sms 6 } -- abstract syntaxes

-- modules

usefulDefinitions ID ::= { id-mod 0 }
relayProtocol      ID ::= { id-mod 1 }
relayAbstractService ID ::= { id-mod 2 }

-- object types

id-ot-SC           ID ::= { id-ot 0 }
id-ot-MS          ID ::= { id-ot 1 }

-- port types

id-port           ID ::= { id-pt 0 }

-- application contexts

id-ac-so          ID ::= { id-ac 0 } -- SC does BIND
id-ac-st          ID ::= { id-ac 1 } -- MSC does BIND

-- application service elements

id-SMRSE          ID ::= { id-ase 0 }

-- abstract syntaxes

id-as-SMRSE       ID ::= { id-as 0 }

END

```

2nd module of 3

RelayAbstractService

```

RelayAbstractService    { iso identified-organization cept(12)
                        gsm(0) sms(5) id-mod(1)
                        relayAbstractService(2) }

DEFINITIONS

IMPLICIT TAGS

 ::=

BEGIN

-- EXPORTS everything

IMPORTS

    BIND, UNBIND
        FROM Remote-Operations-Notation
            { joint-iso-ccitt remote-operations(4) notation(0) }

    OBJECT, PORT, ABSTRACT-BIND, ABSTRACT-UNBIND,
    ABSTRACT-OPERATION, ABSTRACT-ERROR
        FROM AbstractServiceNotation
            { joint-iso-ccitt mhs-motis(6) asdc(2) modules(0)
              notation(1) }

    id-ot-SC, id-ot-MS, id-port
        FROM SMS-UsefulDefinitions
            { iso identified-organization cept(12) gsm(0) sms(5)
              id-mod(1) usefulDefinitions(0) } ;

-- upper bound settings

ub-operator-name-length INTEGER ::=          20

ub-agreem-name-length INTEGER ::=           20

ub-X121Address-length INTEGER ::=          15

ub-password-length INTEGER ::=             20

```

-- Objects

-- The SC and the MSC are modelled as atomic objects, sC-Object
 -- and MSC-Object. Each object has one port for the
 -- interconnection. ([S] and [C] indicate supply and consumption
 -- of services, respectively).

```
sC-Object      OBJECT
                PORTS { sMR-port [C] }
                ::= id-ot-SC
```

```
mSC-Object     OBJECT
                PORTS { sMR-port [S] }
                ::= id-ot-MS
```

-- Port

```
sMR-port       PORT
                CONSUMER INVOKES { Forward-MS-Terminated-Short-
                                Message }
                SUPPLIER INVOKES { Forward-MS-Originated-Short-
                                Message, Alert-SC }
                ::= id-port
```

-- Bind

```
SMR-Bind ::=
                ABSTRACT-BIND
                TO { sMR-port }
                BIND
                ARGUMENT      SMR-Bind-Parameters
                RESULT        SMR-Bind-confirm
                BIND-ERROR    SMR-Bind-failure
```

-- Unbind

-- The UNBIND is a harsh release of the association: all
 -- outstanding operations are aborted, and SMR-ALERT requests may
 -- be lost if they collide with the SMR-UNBIND request. The SC and
 -- the MSC should negotiate (during SMR-BIND) the use of services
 -- on the association (the operations parameter - list of operation
 -- types for the association) in such a way that no harmful losses
 -- of operations occur.

```
SMR-Unbind ::=
                ABSTRACT-UNBIND
                FROM { sMR-port }
                UNBIND
                ARGUMENT      Time-when-connected
                RESULT        Time-when-disconnected
```

-- Association control parameters

```
SMR-Bind-Parameters ::= SEQUENCE {
    initiatorID [0] Name,
    password    [1] Password OPTIONAL,
    pswNeeded   [2] BOOLEAN,
    iniType     [3] Telecom-System-Type,
    operations  [4] List-of-Operations
}
```

-- Above and in SMR-Bind-confirm

```
-- initiatorID / respID identify the initiating/responding
--                       telecommunication subsystem
-- password             may assist in authentication
-- pswNeeded (BIND only) requests password into SMR-Bind
--                       SMR-Bind-confirm
-- iniType / respType  identify the types of the systems
-- operations           lists the SM relay operations
--                       requested and supported on the
--                       association: operations listed
--                       in both the BIND and the CONFIRM
--                       may be used (i.e. this is a
--                       negotiation between SC and MSC)
-- transient (CONFIRM only) forces the association (and the
--                       underlying connections) transient:
--                       it must be UNBOUND as soon as there
--                       are no operations to be performed
```

```
Name ::= SEQUENCE {
    operator           [0] Operator           OPTIONAL,
    bilateralAgreem   [1] BilateralAgreem    OPTIONAL,
    dataNetworkAddress [2] X121Address        OPTIONAL,
    iSDNAddress        SMS-Address           OPTIONAL
}
```

```
-- operator is a text string containing the name of the SC/PLMN
-- operator. bilateralAgreem is a text string identifying the
-- bilateral agreement between the SC and the PLMN operators which
-- allows for this association to be established.
-- dataNetworkAddress is the PSPDN X.121 address of the SC/MSC
-- issuing the BIND or CONFIRM, occurring only if a PSPDN is used.
-- iSDNAddress is the PLMN address of the SC as seen by the MSs
-- (same datum in both BIND and CONFIRM).
```

```
-- Any pair of subsets of these parameters may be used to identify
-- the SC and the MSC to one another.
```

```

Operator ::= PrintableString (SIZE(0..ub-operator-name-length))
BilateralAgreem ::= PrintableString (SIZE(0..ub-agreem-name-length))
X121Address ::= NumericString (SIZE(0..ub-X121Address-length))
-- SMS-Address is specified later in this module.
Password ::= PrintableString (SIZE(0..ub-password-length))
Telecom-System-Type ::= INTEGER {
    short-Message-Service-Centre (0),
    public-Land-Mobile-Network (1)
    -- Extensions are possible:
    -- additional telecommunication
    -- subsystems might adopt this
    -- service element for their
    -- interconnection.
}

List-of-Operations ::=
    BIT STRING {
        sMR-MO-Data-by-MSc (0),
        sMR-MT-Data-by-Sc (1),
        sMR-Alert-by-MSc (2)
        -- Extensions are possible: additional
        -- operations may be defined within this
        -- service element. Existing systems
        -- should tolerate unknown values, but
        -- negotiate not to perform unknown
        -- operations.
    }

sMR-Bind-confirm ::= SEQUENCE {
    respId [0] Name,
    password [1] Password OPTIONAL,
    respType [3] Telecom-System-Type,
    operations [4] List-of-Operations,
    transient [5] BOOLEAN,
    connectTime [6] Time-when-connected
}

sMR-Bind-failure ::= SEQUENCE {
    connect-failure-reason
        [0] Connect-failure,
    alternative-system
        [1] Name OPTIONAL
}

-- connect-failure-reason contains one of the error indications
-- given in the following table. alternative-system is included
-- when the SC/PLMN operator wishes to indicate that the MSC/SC
-- might try to establish an association with another SC/MSC.

```

```

--
--      Error indications      : Reason
-----
--      not-entitled          : The responder is not entitled to
--                          : accept a request for an asso-
--                          : ciation between itself and the
--                          : initiator.
--                          :
--      temporary-overload    : The responder is not capable of
--                          : establishing an association due
--                          : to temporary overload.
--                          :
--      temporary-failure     : The responder is not capable of
--                          : establishing an association due to
--                          : a temporary failure (having impact
--                          : on an entity at SM-RL or at layers
--                          : above).
--                          :
--      incorrect-ID-or-password : The responder will not accept the
--                          : request to establish an associa-
--                          : tion between itself and the
--                          : initiator due to incorrect
--                          : identity or password.
--                          :
--      not-supported         : The responder does not recognize
--                          : the telecommunication subsystem
--                          : type of the initiator, or cannot
--                          : support any of the operations
--                          : suggested on the association.

```

```

Connect-failure ::= INTEGER
                { not-entitled (0),
                  temporary-overload (1),
                  temporary-failure (2),
                  incorrect-ID-or-password (3),
                  not-supported (4)
                }

```

```

Time-when-disconnected ::= UTCTime
Time-when-connected    ::= UTCTime

```

-- The SMR-MT-DATA operation

```

-- SMR-MT-DATA
Forward-MS-Terminated-Short-Message ::=
    ABSTRACT-OPERATION
    ARGUMENT    RPDataMT
    RESULT      RPAck

```

```

ERRORS      { Unknown-subscriber,
              Teleservice-not-provisioned,
              CUG-reject,
              Call-barred,
              Facility-not-supported,
              Absent-subscriber,
              SMS-lower-layer-capabilities-not-prov,
              Error-in-MS,
              System-failure
            }

```

-- SMR-MT-DATA error alternatives listed below

```

Unknown-subscriber ::=
    ABSTRACT-ERROR
    PARAMETER RPErrors

CUG-reject ::=
    ABSTRACT-ERROR
    PARAMETER RPErrors

Teleservice-not-provisioned ::=
    ABSTRACT-ERROR
    PARAMETER RPErrors

Call-barred ::=
    ABSTRACT-ERROR
    PARAMETER RPErrors

System-failure ::=
    ABSTRACT-ERROR
    PARAMETER RPErrors

Facility-not-supported ::=
    ABSTRACT-ERROR
    PARAMETER RPErrors

Absent-subscriber ::=
    ABSTRACT-ERROR
    PARAMETER RPErrors

SMS-lower-layer-capabilities-not-prov ::=
    ABSTRACT-ERROR
    PARAMETER RPErrors

Error-in-MS ::=
    ABSTRACT-ERROR
    PARAMETER RPErrors

```

-- SMR-MT-DATA parameters

-- SMR-MT-DATA parameters

```
RPDataMT ::= SEQUENCE {
    mt-priority-request      [0]    BOOLEAN,
    mt-message-reference     RP-MR,
    mt-originating-address   SMS-address,
    mt-destination-address   SMS-address,
    mt-user-data             RP-UD
}
```

-- SMR-MT-DATA acknowledgement

```
RPAck ::= SEQUENCE {
    message-reference        RP-MR
}
```

```
RPErrror ::= SEQUENCE {
    msg-waiting-set         [1]    BOOLEAN,
    message-reference        RP-MR
}
```

```
RP-MR ::= [APPLICATION 2] INTEGER (0..255)
```

```
RP-UD ::= [APPLICATION 3] OCTET STRING (SIZE (1..255))
```

-- Definition of Short Message Service address

```
SMS-Address ::= [APPLICATION 0] SEQUENCE {
    address-type    INTEGER { unknown-type(0),
                             international-number(1),
                             national-number(2),
                             network-specific-number(3),
                             short-number(4) },
    numbering-plan  INTEGER { unknown-numbering(0),
                             iSDN-numbering(1),
                             data-network-numbering(3),
                             telex-numbering(4),
                             national-numbering(8),
                             private-numbering(9) },
    address-value   CHOICE {
        octet-format
        SemiOctetString
        -- other formats are for further study
    }
}
```

```
SemiOctetString ::= OCTET STRING (SIZE(1..10)) -- each octet contains
-- two binary coded
-- decimal digits
```

```

-- The SMR-MO-DATA and SMR-ALERT operations

-- SMR-MO-DATA
Forward-MS-Originated-Short-Message ::=
    ABSTRACT-OPERATION
    ARGUMENT      RPDataMO
    RESULT        RPAck
    ERRORS        { SC-congestion,
                    MS-not-SC-Subscriber
                  }

-- SMR-ALERT
Alert-SC ::=
    ABSTRACT-OPERATION
    ARGUMENT      RPAAlertSC

-- SMR-MO-DATA error alternatives

SC-congestion ::=
    ABSTRACT-ERROR
    PARAMETER RPErrors

MS-not-SC-Subscriber ::=
    ABSTRACT-ERROR
    PARAMETER RPErrors

-- Parameters

-- SMR-MO-DATA parameters
RPDataMO ::= SEQUENCE {
    mo-message-reference      RP-MR,
    mo-user-data              RP-UD
}

-- SMR-ALERT parameters
RPAAlertSC ::= SMS-Address
                -- must be an international ISDN address

END

```

3rd module of 3

RelayProtocol

```
RelayProtocol { iso identified-organization
                cept(12) gsm(0) sms(5)
                id-mod(1) relayProtocol(1) }
```

DEFINITIONS

IMPLICIT TAGS

::=

BEGIN

-- EXPORTS everything

IMPORTS

-- application service elements and application contexts

```
aCSE, APPLICATION-SERVICE-ELEMENT, APPLICATION-CONTEXT
  FROM Remote-Operations-Notation-extension
  { joint-iso-ccitt remote-operations(4)
    notation-extension(2) }
```

```
rOSE FROM Remote-Operations-APDUs
  { joint-iso-ccitt remote-operations(4) apdus(1) }
```

-- object identifiers

```
id-ac-so, id-ac-st, id-SMRSE, id-as-SMRSE,
  FROM SMS-UsefulDefinitions
  { iso identified-organization
    cept(12) gsm(0) sms(5)
    id-mod(1) usefulDefinitions(0) } ;
```

```
aS-ACSE OBJECT IDENTIFIER ::=
  { joint-iso-ccitt association-control(2)
    abstractSyntax(1) apdus(0) version(1) }
```

-- abstract service parameters

```
Forward-MS-Terminated-Short-Message,
Forward-MS-Originated-Short-Message, Alert-SC,
Unknown-subscriber, Teleservice-not-provisioned, CUG-reject,
Call-barred, Facility-not-supported, Absent-subscriber,
SMS-lower-layer-capabilities-not-prov, Error--in-MS,
System-failure, SC-congestion, MS-not-SC-Subscriber
  FROM RelayAbstractService
  { iso identified-organization
    cept(12) gsm(0) sms(5)
    id-mod(1) relayAbstractService(2) } ;
```

-- Application contexts

-- Two different application contexts are specified:
 -- one for the case when the SC BINDs (and UNBINDs),
 -- and the other for the case when the MSC BINDs (and UNBINDs).
 --
 -- There is only one application service element, however
 -- (see "Application service elements" below.)

sC-BINDs-and-UNBINDs

```
APPLICATION-CONTEXT
APPLICATION-SERVICE-ELEMENTS { aCSE }
BIND      SMR-Bind
UNBIND    SMR-Unbind
REMOTE OPERATIONS { rOSE }
INITIATOR CONSUMER OF { sMRSE }
ABSTRACT SYNTAXES { id-as-SMRSE , aS-ACSE }
 ::= id-ac-so
```

mSC-BINDs-and-UNBINDs

```
APPLICATION-CONTEXT
APPLICATION-SERVICE-ELEMENTS { aCSE }
BIND      SMR-Bind
UNBIND    SMR-Unbind
REMOTE OPERATIONS { rOSE }
RESPONDER CONSUMER OF { sMRSE }
ABSTRACT SYNTAXES { id-as-SMRSE , aS-ACSE }
 ::= id-ac-st
```

-- Application service elements

```
sMRSE  APPLICATION-SERVICE-ELEMENT
        CONSUMER INVOKES { forward-MS-Terminated-Short-Message}
        SUPPLIER INVOKES { forward-MS-Originated-Short-Message,
                           alert-SC }
 ::= id-SMRSE
```

-- Remote operations

forward-MS-Terminated-Short-Message

```
Forward-MS-Terminated-Short-Message
 ::= 1 -- Note: localValue -words omitted, since
       -- they are typically not used, and likely
       -- to be removed from the OPERATION and
       -- ERROR macros in ROSE.
```

forward-MS-Originated-Short-Message

```
Forward-MS-Originated-Short-Message
 ::= 2
```

alert-SC Alert-SC

```
 ::= 3
```

-- Remote errors

```
unknown-subscriber
    Unknown-subscriber
    ::= 1

cUG-reject CUG-reject
    ::= 15

teleservice-not-provisioned
    Teleservice-not-provisioned
    ::= 11

call-barred Call-barred
    ::= 13

system-failure
    System-failure
    ::= 36

facility-not-supported
    Facility-not-supported
    ::= 21

absent-subscriber
    Absent-subscriber
    ::= 29

SMS-lower-layers-capabilities-not-prov
    SMS-lower-layer-capabilities-not-prov
    ::= 19

error-in-MS
    Error-in-MS
    ::= 20

sC-congestion
    SC-congestion
    ::= 101

mS-not-SC-Subscriber
    MS-not-SC-Subscriber
    ::= 103
```

END

7. Application rules for avoiding collisions between SMR-UNBIND and the other SMRSE operations

The symmetric asynchronous way of using the SMRSE operations may lead to a collision between the SMR-UNBIND operation and another operation. This may cause the unwanted abortion of SMR-MO-DATA or SMR-MT-DATA operations, and/or the loss of SMR-ALERT operations.

(In order to guarantee the completion of all the SMRSE operations, the Session negotiated release functional unit might have been specified on the session layer and the SMR-UNBIND mapped on that negotiated release. However, the Session negotiated release functional unit requires also the Session half duplex functional unit. The negotiated release functional unit is not used anywhere else in the GSM recommendations, hence it was not adopted here either.)

The proper completion of all the SMRSE operations is guaranteed by avoiding collisions between SMR-UNBIND and other operations. This is achieved by following application rules which restrict the invocation of different operations on the association. Two alternative sets of application rules are given in 7.1 and 7.2 in the sequel; additional sets are possible.

7.1 Application rule set 1: Semi-permanent symmetric connection

This set of application rules is to be used in situations where the connection (on all the protocol layers) between the SC and the MSC is maintained for ever.

Within the SMR-BIND service, all operations are allowed on the association; semi-permanent connection is accepted (by not forcing the connection transient). This is negotiated within the SMR-BIND service as follows:

<u>name of parameter</u>	<u>value in request and report</u>
operations	{ SMR-MO-Data-by-MSC, SMR-MT-Data-by-SC, SMR-Alert-by-MSC }
transient	FALSE (in report only)

The association is used fully asymmetrically, the parties invoke SMR-MO-DATA, SMR-MT-DATA, and SMR-ALERT operations as needed.

The SMR-UNBIND operation is never invoked on the association.

7.2 Application rule set 2: Transient asymmetric connection

This set of application rules is to be used e.g. in situations where one SC has connections with many MSCs or vice versa, and there is a switched data network connecting them. A data network connection (and the higher layer connections on top of it) is maintained for the duration of the relay or alert operations only.

Within the SMR-BIND service, only one type of operations is negotiated for use on the association. (As an exception, an association for both SMR-MO-DATA and SMR-ALERT is allowed below.) The operations of that type must be invoked by the initiator of the SMR-BIND. The responder of the SMR-BIND accepts the one type of operations and forces the association transient.

The following is an example of negotiating this within the SMR-BIND service; here, the SMR-MT-DATA operations are to be initiated by the SC.

<u>name of parameter</u>	<u>value</u>
iniType	short-Message-Service-Centre
respType	public-Land-Mobile-Network
operations	{ SMR-MT-Data-by-SC }
transient	TRUE

The association for SMR-MO-DATA or SMR-ALERT is negotiated according to the same principle, the MSC being the initiator of the SMR-BIND.

As an exception to the single type of operations rule, the following SMR-BIND negotiation for both SMR-MO-DATA and SMR-ALERT is allowed in this application rule set:

<u>name of parameter</u>	<u>value</u>
iniType	public-Land-Mobile-Network
respType	short-Message-Service-Centre
operations	{ SMR-MO-Data-by-MSC, SMR-Alert-by-MSC }
transient	TRUE

The association may be used for invoking operations of the negotiated type(s) as long as there are such operations to be invoked. (In other words, until all short messages or/and alerts to that direction have been relayed.)

If SMR-ALERT is not allowed on the association, the SMR-UN-BIND operation may be invoked on the association as soon as all operations on the association have been completed (by REPORT or ERROR). If SMR-ALERT is allowed, a guard time since the last SMR-ALERT invocation (if any) must have elapsed also (to guarantee that the SMR-ALERTS have been processed - there will be no responses).

This set of application rules effectively makes the association asymmetric: all operations are invoked by the same party, hence collisions are not possible.

8. Timing terminology

The overall delay of a short message relay operation between an SC and an MS may be affected i.a. by the following delays:

- a) transport connection establishment time between an SC and an MSC (including the time spent establishing a new network connection, if needed),
- b) the time needed to establish the higher layer protocol connections on top of the transport connection (including the SMR-BIND operation), and
- c) the time needed (request to result) for the actual remote operation (SMR-MO-DATA or SMR-MT-DATA) relaying the SM.

If semi-permanent connections are used, only the delay (c) is likely to occur.

As an aid to the organizations discussing these delays in actual implementations, the following time/count-valued constants are defined in the remainder of this section:

T-failure-delay
A/tr-typical-delay
A/tr-failure-delay
A/pe-typical-delay
A/pe-failure-delay
R/MO/1-typical-delay
R/MO/n-typical-delay
R/MO-failure-delay
R/MT-typical-delay
R/MT-failure-delay
R-OK-load
R-error-load
R/MO-OK-outstanding
R/MT-OK-outstanding

The delay (a) is dependent on the network being used. A delay exceeding T-failure-delay when establishing a transient transport connection should be treated as a failure, despite the worst-case delay specification of the network used.

The delay (b) for transient connections is typically A/tr-typical-delay, and a delay exceeding A/tr-failure-delay should be treated as a failure.

The delay (b) for semi-permanent connections is typically A/pe-typical-delay, and a delay exceeding A/pe-failure-delay should be treated as a failure.

The delay (c) for the SMR-MO-DATA service is typically R/MO/1-typical-delay if no other SMR-MO-DATAs are outstanding, and R/MO/n-typical-delay if there are other SMR-MO-DATAs outstanding. In either case, a delay exceeding R/MO-failure-delay should be treated as a failure.

The delay (c) is typically R/MT-typical-delay for the SMR-MT-DATA service (PLMN delays involved), and a delay exceeding R/MT-failure-delay should be treated as a failure.

Concerning throughput and overloading, a SMRSE responder is capable of processing R-OK-load SMRSE operations per minute and properly rejects (via error) up to R-error-load operations per minute if the actual processing throughput is exceeded. (Failing SMR-ALERTs do not cause any response, though.) The maximum number of outstanding SMR-MO-DATA operations on an application association must not exceed R/MO-OK-outstanding, if all operations are to be properly processed. The corresponding limitation for SMR-MT-DATAs is R/MT-OK-outstanding.

ANNEX 2

DEFAULT ALPHABET AND CODING SCHEME

The default 7-bits coded alphabet for SMC-CB is the following:

					b7	0	0	0	0	1	1	1	1
					b6	0	0	1	1	0	0	1	1
					b5	0	1	0	1	0	1	0	1
b4	b3	b2	b1		0	1	2	3	4	5	6	7	
0	0	0	0	0	@	o	SP	0	i	P	z	p	
0	0	0	1	1	f	l)	!	1	A	Q	a	q	
0	0	1	0	2	\$	ø	"	2	B	R	b	r	
0	0	1	1	3	¥	τ	#	3	C	S	c	s	
0	1	0	0	4	è	λ	œ	4	D	T	d	t	
0	1	0	1	5	é	Ω	%	5	E	U	e	u	
0	1	1	0	6	ù	π	&	6	F	V	f	v	
0	1	1	1	7	ì	Υ	'	7	G	W	g	w	
1	0	0	0	8	ò	Σ	(8	H	X	h	x	
1	0	0	1	9	ç	θ)	9	I	Y	i	y	
1	0	1	0	10	LF	≡	*	:	J	Z	j	z	
1	0	1	1	11	o	l)	+	;	K	Ä	k	ä	
1	1	0	0	12	φ	Æ	,	<	L	Ö	l	ö	
1	1	0	1	13	CR	æ	-	=	M	Ñ	m	ñ	
1	1	1	0	14	À	β	.	>	N	Ü	n	ü	
1	1	1	1	15	á	É	/	?	O	Ş	o	à	

Note: The characters marked "l)" are not used but are displayed as a space.

If a character number *a* is noted in the following way:

aa ab ac ad ae af ag

the packing of the 7-bits characters in octets is done by completing the octets with zeros on the left.

For examples, packing:

- one character in one octet:

bits number:	7	6	5	4	3	2	1	0
	0	1a	1b	1c	1d	1e	1f	1g

- two characters in two octets:

bits number:	7	6	5	4	3	2	1	0
	2g	1a	1b	1c	1d	1e	1f	1g
	0	0	2a	2b	2c	2d	2e	2f

- three characters in three octets:

bits number:	7	6	5	4	3	2	1	0
	2g	1a	1b	1c	1d	1e	1f	1g
	3f	3g	2a	2b	2c	2d	2e	2f
	0	0	0	3a	3b	3c	3d	3e

- eighth characters in seven octets:

bits number:	7	6	5	4	3	2	1	0
	2g	1a	1b	1c	1d	1e	1f	1g
	3f	3g	2a	2b	2c	2d	2e	2f
	4e	4f	4g	3a	3b	3c	3d	3e
	5d	5e	5f	5g	4a	4b	4c	4d
	6c	6d	6e	6f	6g	5a	5b	5c
	7b	7c	7d	7e	7f	7g	6a	6b
	8a	8b	8c	8d	8e	8f	8g	7a

The bit number zero is always transmitted first.

Therefore, in 140 octets, it is possible to pack $(140 \times 8) / 7 = 160$ characters.

ANNEX 3

Short message Information flow

(This annex is not an integral part of this recommendation.)

The diagrams in this Annex describe the flow of primitives and parameters during the short message transfer. These diagrams refer to GSM Recommendations 03.40, 04.11 and 09.02. The parameters in dotted lines are optional.

The abbreviations used in diagrams are listed below. The relevant recommendations are given in paranthesis. (*) stands for a common GSM abbreviation and (-) for a general abbreviation.

List of abbreviations

CM	Call Management (*)
CS	CauSe (-)
DA	Destination Address (-)
DCS	Data Coding Scheme (03.40)
HLR	Home Location Register (*)
IMSI	International Mobile Subscriber Identity (*)
MMS	More Messages to Send (03.40)
MR	Message Reference (03.40)
MS	Mobile Station (*)
MSC	Mobile services Switching Centre (*)
MSI	Mobile waiting Set Indication (03.40)
MSISdn	Mobile Station ISDN number (*)
MSRN	Mobile Station Roaming Number (*)
MT	Message Type (04.11)
MTI	Message Type Indicator (04.11)
MWS	Message Waiting Set (03.40)
OA	Originating Address (-)
OC	Operation Code (09.02)
PCI	Protocol Control Information (-)
PDI	Protocol DIscriminator (*)
PRI	PRiority (03.40)
RL	Relay function (04.11)
SC	Service Centre (03.40)
SCA	Service Centre Address (03.40)
SCTS	Service Centre Time Stamp (03.40)
SM	Short Message (03.40)
SM-AL	Short Message Application Layer (03.40)
SME	Short Message Entity (03.40)
SMI	Short Message Identifier (03.40)
SM-RL	Short Message Relay Layer (03.40, 04.11)
SMS-GMSC	Short Message Service Gateway MSC (03.40)
SMS-IW MSC	Short Message Service Interworking MSC (03.40)
SoR	Status of Report (03.40)
SM-TL	Short Message Transfer Layer (03.40)
TCAP	Transaction Capabilities Application Part (-)
TID	Transaction Identifier (*)
UD	User Data (-)
UDL	User Data Length (03.40)
VLR	Visitor Location Register (*)
VP	Validity Period (03.40)
VPF	Validity Period Format (03.40)

MOBILE TERMINATED SHORT MESSAGE

PICTURE 2

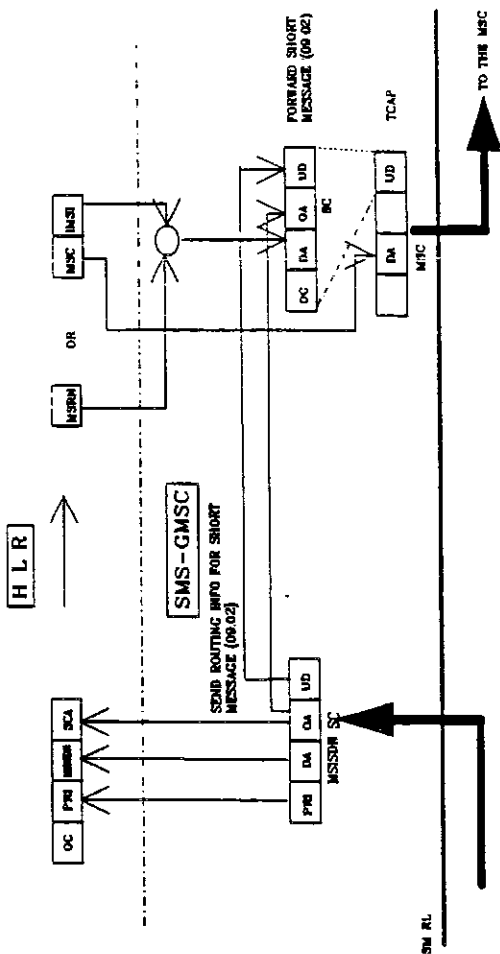

MOBILE TERMINATED SHORT MESSAGE

PICTURE 4

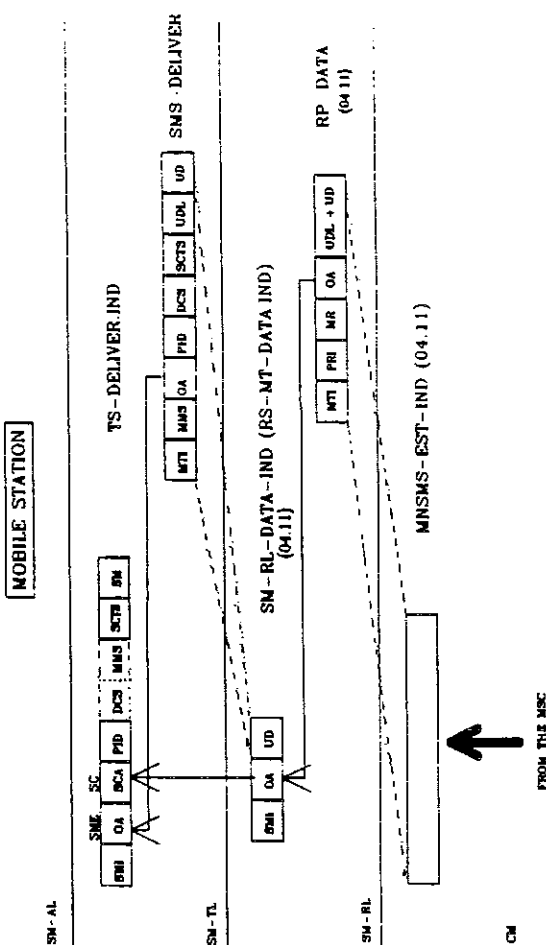

MOBILE TERMINATED SHORT MESSAGE

PICTURE 1

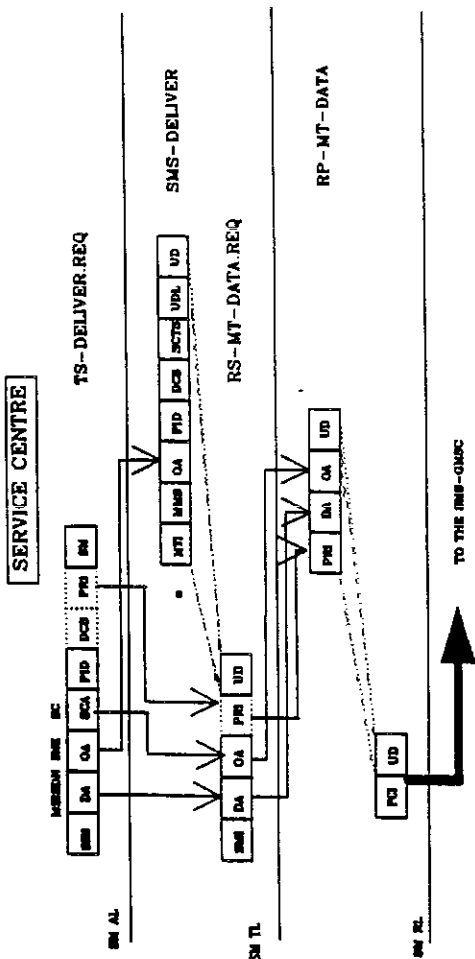

MOBILE TERMINATED SHORT MESSAGE

PICTURE 3

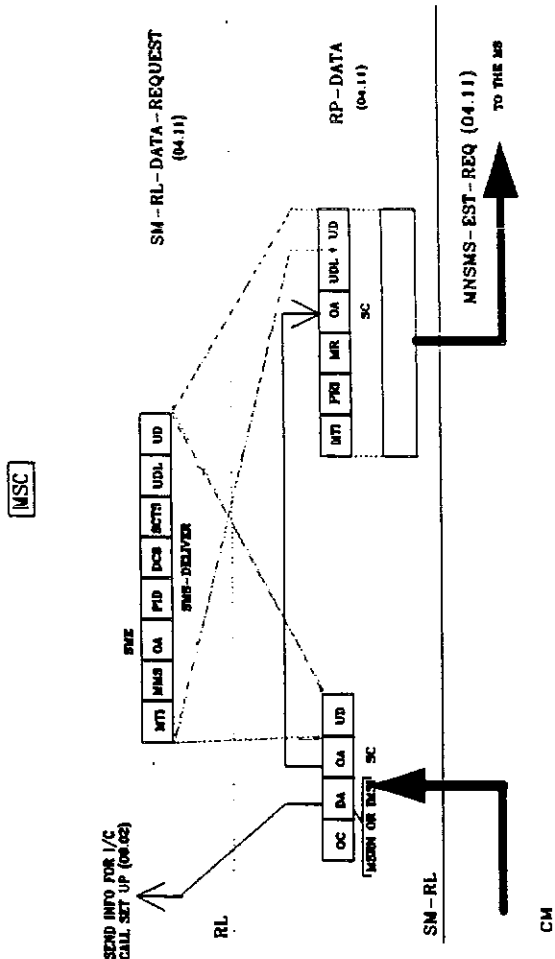

ACKNOWLEDGEMENT IN THE MT CASE

PICTURE 2

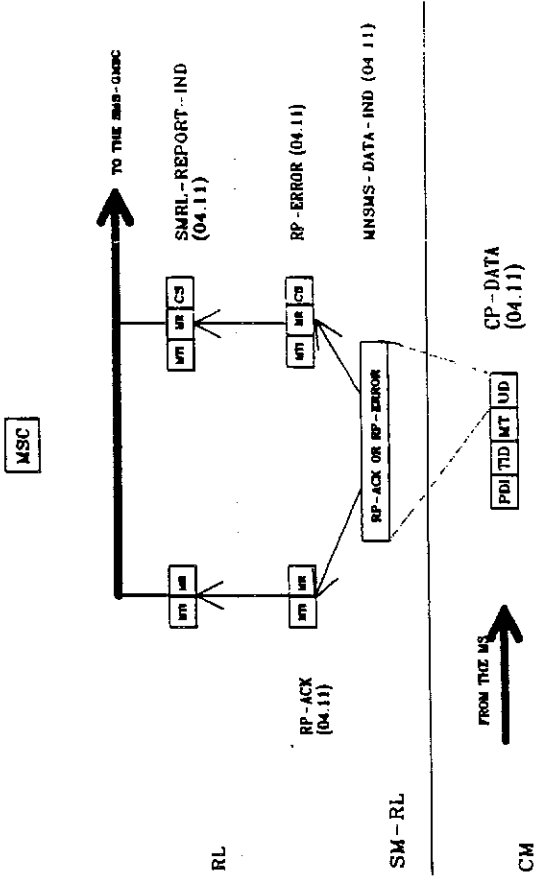

ACKNOWLEDGEMENT IN THE MT CASE

PICTURE 1

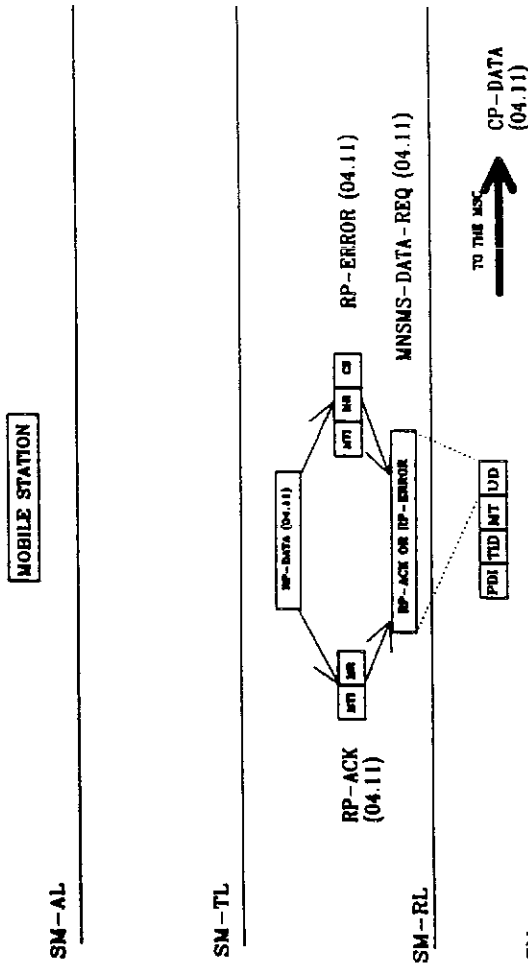

ACKNOWLEDGEMENT IN THE MT CASE

PICTURE 3

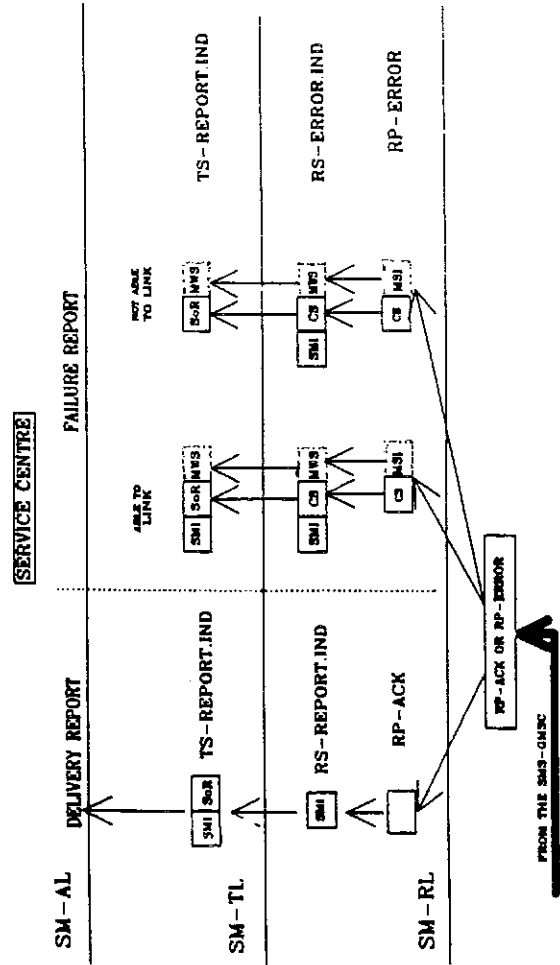

MOBILE ORIGINATED SHORT MESSAGE

PICTURE 1

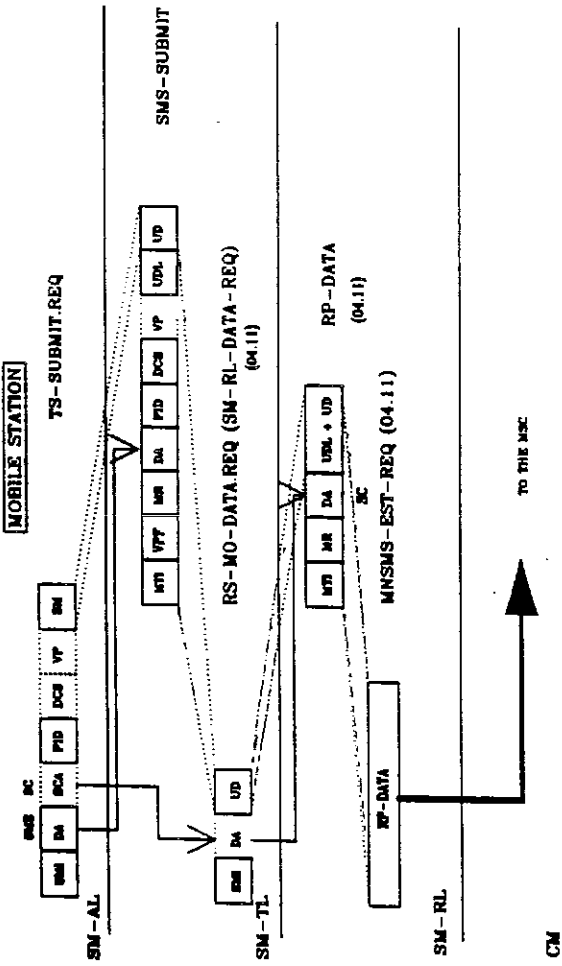

MOBILE ORIGINATED SHORT MESSAGE

PICTURE 3

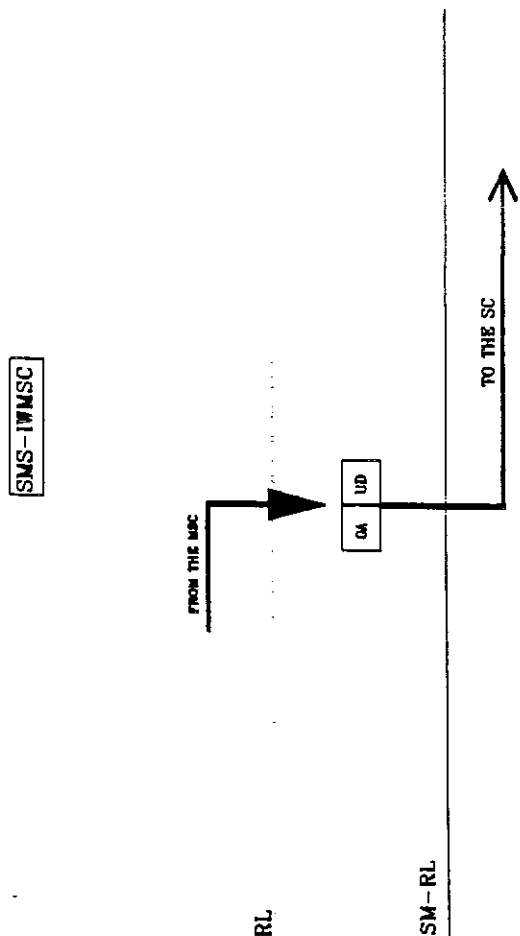

MOBILE ORIGINATED SHORT MESSAGE

PICTURE 2

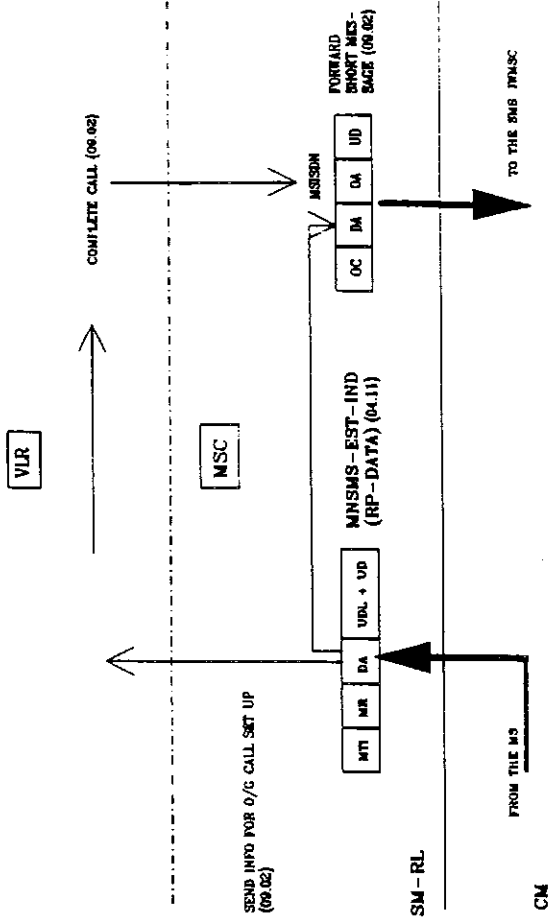

MOBILE ORIGINATED SHORT MESSAGE

PICTURE 4

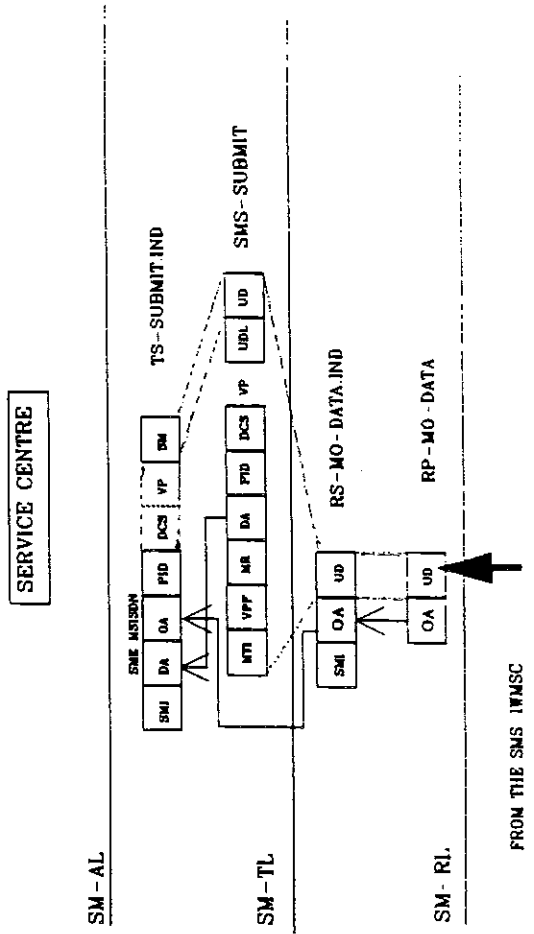

ACKNOWLEDGEMENT IN THE MO CASE

PICTURE 2

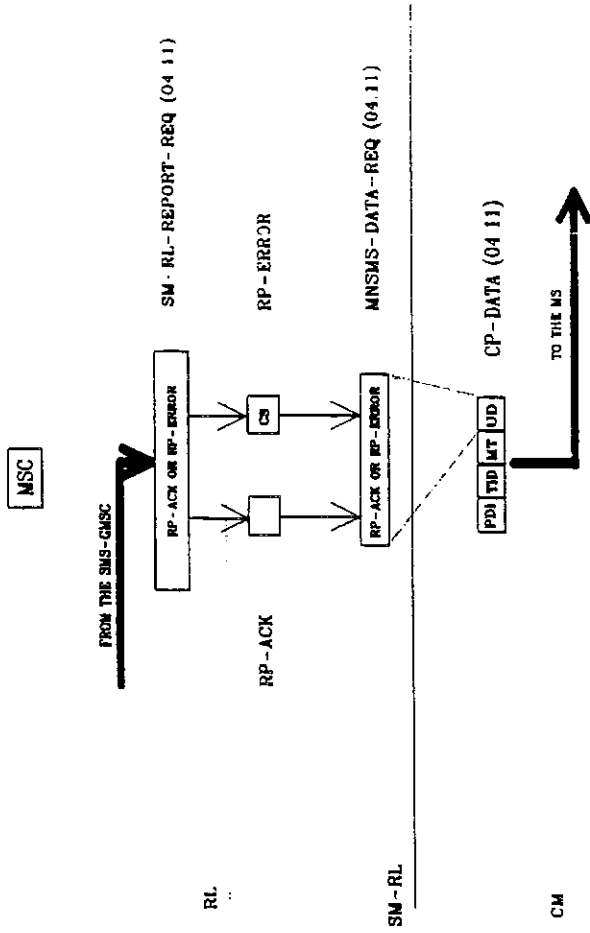

ACKNOWLEDGEMENT IN THE MO CASE

PICTURE 1

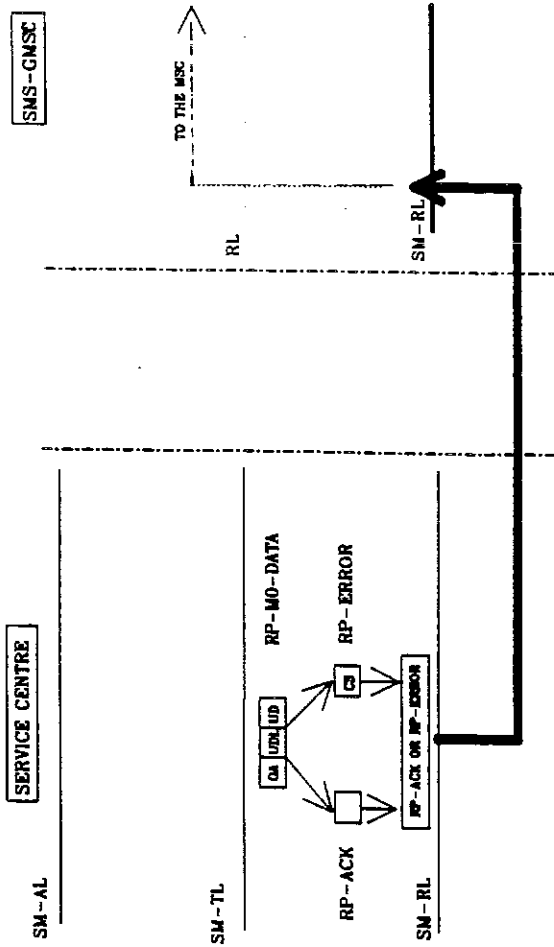

ACKNOWLEDGEMENT IN THE MO CASE

PICTURE 3

